

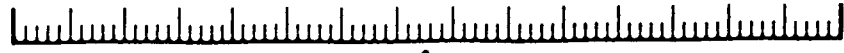

# ZERO BEAT



AMSAT

## Hampden County Radio Association

Springfield, MA

March 1985

ARRL Affiliated, 37th Year

### Next Meeting

## THE ATV STORY

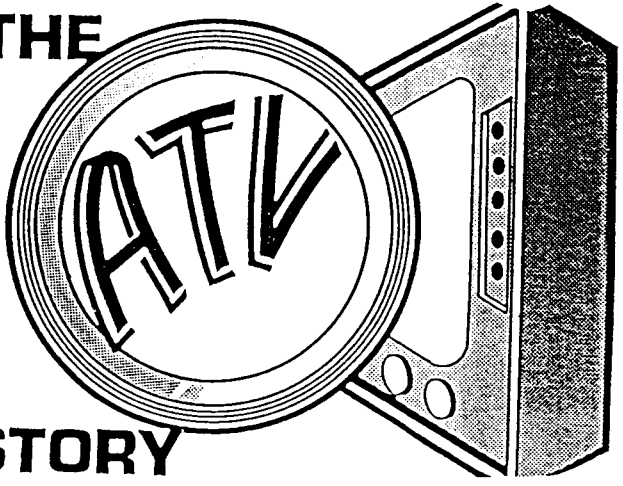

FRIDAY MARCH 1st  
LIVE AMATEUR  
TELEVISION DEMO!!!

Chet, W1HGJ and  
Bob, W1NYP

Will delve into ATV so that  
all can understand!!!!

Friday March 1st!  
Feeding Hills Cong. Church  
Center of Feeding Hills  
Routes 57 and 187  
Doors open at 7:30 PM  
Meeting starts promptly at 8:00 PM

Please, no smoking during  
the meeting! Thank you!



NO SMOKING

### IN THIS ISSUE:

- ATV How to get started!
- Our new repeater group!
- DX column by W1DGJ!
- Membership application

### IN UPCOMING ISSUES:

- More on what we're going to accomplish with the repeater group.
- Handling semi-conductors by W1NPL
- OSCAR antenna Polarity by W1KK
- Special Event Station for Springfield's Basketball Hall of Fame grand opening
- Packet Radio
- Plus regular feature like
- Tidbits, CQ DX, etc!

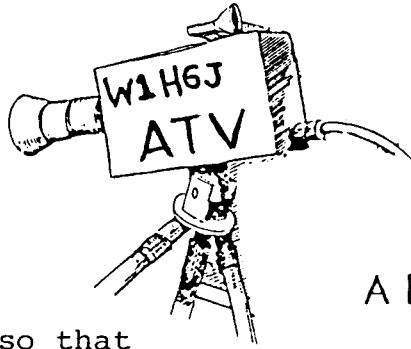

### A Bold New Experiment...

This issue of *ZERO BEAT* is being mailed to over 500 active hams throughout the area! We want you to join our newest group and get in on the fun. Remember that it doesn't officially start until September 1st, 1985, so by signing up today, you'll get 18 months membership for the price of 12! Read the articles and decide. The enclosed membership application should be returned to the club address, with checks made payable to the "HCRA".

Dues are \$9.00 per season, September thru June. Please mail to: N1AEH, Greg Stoddard, 1500 Mapleton Avenue, Suffield, CT 06078. Thank you!

# How to Get Started on ATV

**WHY GET ON ATV?** You can transmit live action color broadcast quality video from cameras, video tape recorders, computers, or any video source. Show the shack, home movies and tapes, schematics and projects, etc. in video while talking on the tv sound subcarrier. DX is similiar to 2 meter FM simplex using omni antennas compared to 70 CM ATV using beam antennas. Typically 15 to 100 miles.

The receiving station sees and hears you thru his TV set and at the same time can talk back for full duplex audio on 2 meter FM. There are a number of repeaters in operation and some have special outputs for weather radar, parades, races, Civil Air Patrol searches, and other public service operations. Some have put ATV in RC model airplanes to fly by video, or made small portable atv transmitters that were placed atop their cameras to transmit back to a video tape recorder or public service command post. The applications are endless.

ATV is really not much different than getting on any new band or mode. It takes another rig and antenna system plus the incentive to communicate with another ham interested in the same mode. You already have 90% of the receiver, a standard TV set. You only need add a downconverter to bring the 420-450 MHz band down to channel 2, 3, or 4 into the TV set antenna terminals. Since ATV uses the same basic sync rates as broadcast, no special scan converters are necessary. In fact that is why low cost or used black and white servielence cameras, computers, etc. can be used. The tansmitter is a AM rig with a wideband modulator to accept video frequencies up to at least 4 mHz and the FM sound subcarrier at 4.5 mHz.

To find other ATVerS in your area contact us, local ARRL SCM, radio clubs, or try one of the more popular two meter simplex FM coordinating frequencies: 144.34, 144.90, and 146.43. The most used ATV frequencies are: 439.25 simplex and repeater input in the east, 434.0 simplex and repeater input in the west and parts of the east that have UHF FM repeaters in the 440-450 segment, 426.25 simplex, and 421.25 repeater output. Some areas use 1253 mHz for crossband repeater output and 1241 for simplex or duplex ATV.

Further written information can be found in chapter 14 of the ARRL Handbook, "Everything You Always Wanted to Know About ATV" book, and Amateur Television Magazine.

**BUILD OR BUY?** If you are more into operating and can't wait to televise your shack, video tapes, computer games, etc. then you will probably want to get the complete unit ready to go . . . TC-1 Transmitter/converter. If you enjoy putting your own system together then the four basic modules are for you. Later you may want to add some of the various accessories.

But either way the most important part of you system is the antenna and transmission line. We suggest the 48 element J beam either single or dual up at least 40 feet or above the tree tops as far as practical. Foliage really absorbs 400 mHz RF. Coax also has a lot of attenuation. Saxton 8285 has the lowest loss of all the 1/2" coaxes at 3.5 db/100'. RG 213 is 4.7 db. Use 50 ohm hardline for runs over 75'. Take great care in making the connectors properly and then tape and spray with clear epoxy paint to keep the water out of the coax. Verticle polarization is is recommended as you may want to get a repeater later and it is hard to get a horizontal omni gain antenna.

At UHF frequencies all coax connections must be as short as possible. The center conductor should never be longer than 1/4" out of the cable for connection. Its usually a good idea to shield the FMA5 and the TXA5 in separate boxes to keep the RF out of the mic amps. Use a good T/R relay such as the Magnacraft W120X-14 or Dow Key type 60 or pull one out of an old surplus UHF FM transmitter. The relay must be made for UHF and low VSWR.

**CONNECTING TO THE TV SET.** In most cases, RG59 or RG6 is run between the downconverter and the TV set antenna input connector. If your TV does not have a coax "F" connector input you will have to add a balun to transform to the 300 ohm twin lead terminals. In this case there may be some strong adjacent channel interference. Fine tune to which ever tv channel is open in your area from channel 2 to 4 for minimum interference. Then tune the downconverter for an atv station you have coordinated with on 2 meters to aim his antenna at you. If you still experience some interference, then all the twin lead from the antenna terminals to the VHF tuner may have to be removed and replaced with coax. Use caution however, as most TV sets have a hot chassis thru one side of the AC line and if the coax is not isolated from the chassis thru a balun or transformer, you could be shocked or sparks fly. If an ATVer is not handy to make the initial tests, out TVG-1 ATV test gen is an inexpensive mighty milliwatt video transmitter which can give you a fair picture up to a 1/4 mile or more.

**ADDING ON TO THE SYSTEM.** There are accessories, for monitoring your own xmitted video, modifying a TV into a monitor, adding S-meter and squelch to the TV receiver, video lDer and clock, a board to super-impose your microcomputer on the camera video, black & white and color cameras. Show your video tapes by just connecting the video output jack of your VCR to the video input of the xmtr. Aim the TV camera at the projection screen to show your home movies. Make your station run on 12VDC for mobile, and or use atv for public service events like parades and races. Let your imagination go!

## MODULAR ATV SYSTEM BLOCK DIAGRAM

(TC-1 INSIDE DOTTED LINE)

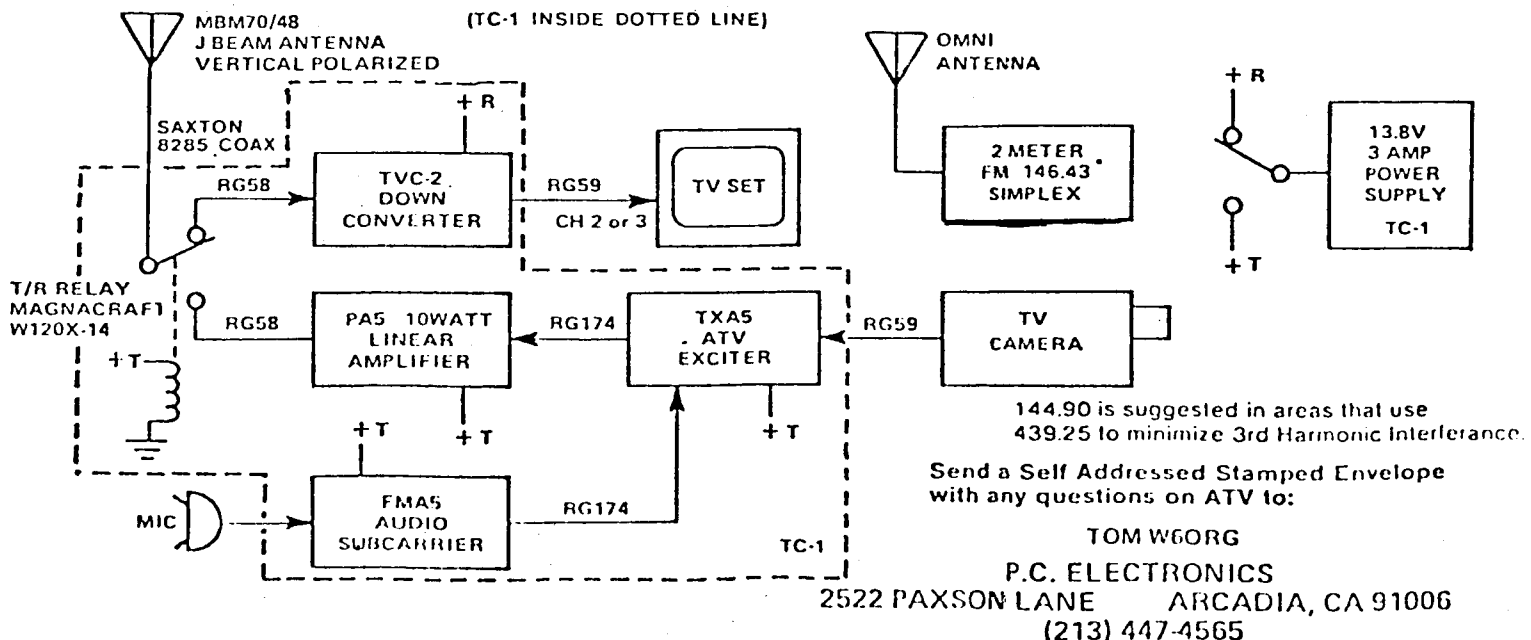

# ZERO BEAT

JANUARY 12th VE SESSION

Some of those who upgraded successfully:

NEW LICENSE

Bob Barrett	Novice
Phil Langlois	Technician
KALKPH	Advanced
WB1DTH	Advanced
KALKRJ	20 wpm
KALMEW	Technician
KALMDA	Technician
W1HOD	Advanced
N3ADQ	Extra
KALMEP	General
KALLYN	General
KALMBK	Technician
W2DYQ	20 wpm
KALMIT	Technician
KAL1XT	Technician
NICET	General
KALITH	Advanced

-Congratulations to one and all-

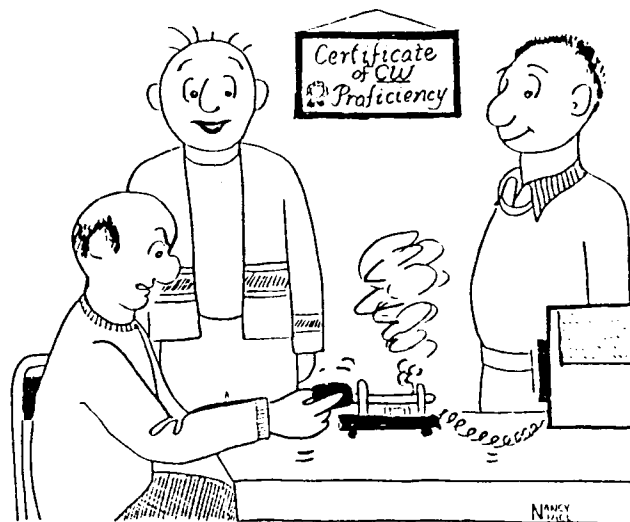

"He sure loves that high-speed CW!"

January 14, 1985

Board of Directors  
Hampden County Radio Association  
c/o John E. Balboni AC1T  
188 Walnut Street  
Agawam, Mass 01001

Dear friends:

As coordinator of communications for the Holyoke Saint Pat's parade and the Mt. Holyoke Regatta for several years I am most aware of the importance of volunteers in the successful completion of any effort.

Therefore I wish to speak for myself, and hopefully for many others, in expressing warm thanks and appreciation to the HCRA for the Volunteer Examiner program held this past Saturday, January 12, 1985.

K1BXs, W1EYF and K1BE as examiners, with a strong support team, conducted the examinations with decorum, dignity and authority in the highest standards... a credit to the HCRA and amateur radio in general.

I thank all and look forward to the study program and sitting for the Extra Theory examination later on this year.

73

E. Albert Webb W1HOD ( since 1933)  
W1HOD/AA since 1-12-85!)

This is to provide background information on how your newsletter is run! It is published every month, except July and August, and mailed to every paid up member of the HCRA. Articles submitted by the 15th of the previous month will usually be printed in that issue. Anything that arrives between the 16th and the 20th may or may not get in. It depends on how much room is left, and if the issue is finished. As you have noticed, we are going over to a two column, side by side format, with reduced print size. This saves money, and we can print more articles. (ZB costs over \$125.00 per issue.) However, because we have about a two month backlog of articles at any one time, we can't re-type the ones already finished, so that's why you'll still see a mix of full page and two columns.

Around the twentieth the issue is dropped off at the printers. WB1ETS prints out the mailing labels every month. The printed pages and the labels make their way to a drop off point in West Springfield. There K1BUB picks everything up. Bob and his family, including the kids, Nicole, Nadine, Melissa, and Jonathan collate the pages, stick on the stamps and labels, and Bob or Jan mail it. Hopefully it arrives about one week before the meeting!

To reduce costs, the Board of Directors has asked that I keep each issue under four pages. With all the fine articles you send in, it's hard. However, I'll keep trying! Ads, either to sell or buy are always welcome. Tidbits about your activities are solicited, as are articles! Write today and share the wealth!

## Tidbits

WB1GTR won the Freedom Foundation Award! This is the second time Jack has won. FB!...Bob Barrett passed his novice test at our VE session in January. What makes it so special is that Bob was originally licensed 60 years ago! Welcome back...W1KK busy on the OSCAR satellite...KALMCA received one of those pocket size rigs by Kenwood for 70 cm for his birthday...WALYYK kept busy passing traffic on the nets...W1MM relived his past glories as a football star in a feature article in a sports magazine...KALEUJ teaches math at Westfield State College...WB1CAC working for Rathenon Corp...

**DROP US  
A LINE!**

# A Bold New Experiment...

## Background

For many years now there have been a few small groups in the greater Springfield area working individually on various communications projects. It has been often noted that the outcome of these projects yields very interesting additions to the Amateur community, but they often go unacknowledged because of the lack of a structure to distribute information as well as gather support for their continued activities.

In addition, many local Amateurs, not privileged with the opportunity to travel to other parts of the country, have no knowledge of the different types of activity occurring in other metropolitan areas. In comparison, greater Springfield ranks quite low when you compare the current offerings with that of other localities across the country. Part of the blame for this situation must fall on the local club organizations, for without organized support, many ideas can never be implemented.

The HCRA board of directors has been working on agreements which will, for the first time, unite the small groups of innovators with the general Amateur community of Hampden County. The result should be a network of high tech communications systems that will spark new interest for current Amateurs, attract more talent and new hams into the hobby, and provide a high quality public service offering to the community.

## Repeaters

In all areas of the world 2m FM has been widely accepted as the local mode of communicating. One can obtain a HT for less than \$200.00 and, coupled with a repeater, communicate over a wide area. It is a little known fact that the first Amateur repeater was located right here in Springfield! It was staffed and manually operated by the control operators.

For many years now Springfield has been provided with a number of repeaters that provide basic service and excellent coverage. Unfortunately, although many computer based features have been added to the most of the available HT offerings, not many features have been added to the area facilities. This, in part, may explain why many groups are privately implementing advanced functionality in local repeaters.

## Communications System

In summary, Hampden County does not need another repeater. As it is now, there are local repeaters that are up and on the air going virtually unused! What Hampden County does need is a communications system; where hams with common interests can meet and experiment; where interest in Amateur radio can be generated bringing new hams into the hobby; where the system continuously evolves offering new fresh challenges for local hams.

We believe that the HCRA is the organization that can meet that challenge, to build such a communications system. We have the talent, the organizational skills and now have the support from the smaller local groups that have been consistent in building what will be the backbone of an extensive state of the art communications network. These individuals realize the benefits of incorporating resources in search of one goal. The HCRA can provide a variety of services such as fund raising, newsletters, and member services while the repeaters and other facilities will provide a vital link, not only between hams, but between hams and the people of Hampden County.

## Offerings

Ray, KA1JUM, has offered use of the 147.105 MHz repeater on Wilbraham Mountain. This machine is a solid state Motorola unit in one of the best locations in the area. Ray and his group are currently working on further upgrades of the station, including a new transmit antenna. The coverage of this repeater is very good.

Chet, WIHGJ, has offered use of the new ATV repeater that should be on the air shortly. This will be also located on Wilbraham Mountain at the KA1JUM 2m repeater site. Extensive work has been done on this project, and it is hoped that the availability of an ATV repeater will spark further interest in this aspect of the hobby.

Bob, KA1KPH-1, has offered use of the Packet Radio digipeater, which is currently running on 145.010 MHz (simplex) from the WIKK/WINY QTH. Packet radio is the newest addition to the digital modes and is gaining in popularity around the country. This repeater will provide a vital link in the growing network of stations linked together up and down the east coast. As the development of packet radio progresses it is noted that some day the entire country will be networked together. The NTS of the future will most likely utilize this mode for traffic.

Bob, KA1KPH, has put together a 70cm RCA repeater on with an Advanced Computer Controls RC-850 repeater controller. This configuration will also be linked with 10m equipment provided by John, AC1T, and 6m equipment obtained from the HCRA.

You can hear the RC-850 controller in operation in Coventry, CT on 147.375 MHz at K1JCL, and in Newington, CT on 145.450 MHz at W1AW. In Keene, NH on 147.375 MHz at K1XR.



KA1JUM/R SPECIFICATIONS	
Frequency:	147.105 output 147.705 input
Mode:	FM
Equipment:	Motorola Micor, with band-pass cavities, microprocessor controller, Isopole antenna.
Coverage:	North -Southern Vermont South -Southern Connecticut West -Albany, N.Y. East -Worcester area
Trustee:	Ray Weber
Other:	This is located atop Wilbraham Mountain and has been in service for years.

## Features

In the following few paragraphs we will attempt to describe some of the features that we envision should be made available with the incorporation of the HCRA communications systems.

**Linking** A repeater that stands alone is not as effective as one that offers links outside its normal coverage area. For example, the K1XR repeater in Keene, NH offers additional links on 2m to other repeaters, one in Vermont, and one in eastern New Hampshire. In addition, K1XR also has links on 220 MHz and 440 MHz. The 440 link is often used to hookup with the 440 machine on Mt. Wachusett in central Massachusetts. K1JCL in CT has multiple 2m receiver sites to extend its coverage area, as well as links to other bands.

The linking of the HCRA communications systems with other facilities outside the greater Hampden County area should prove to be invaluable in such activities as Weather Nets and ARES functions. Ray, KAIJUM, has created a very valuable and visible relationship between the weather service and the ham community. This activity can be greatly enhanced by the offering of expanded facilities supported by an organization dedicated to public service. The western Massachusetts ARES can be greatly enhanced by a possible cooperative venture between the HCRA and other clubs providing extensive coverage of all of western Massachusetts.

**Cross Band Links** With crowded 2m band conditions and the availability of low cost equipment for other frequencies, many hams have been investing in other bands. Although this is more evident in large cities, it is becoming a reality here in Springfield with more and more people appearing on 440 FM. A communications system will have to be responsive to this demand!

KAIKPH-1 SPECIFICATIONS

Frequency: 145.010 simplex  
 Mode: Packet  
 Equipment: Drake TR-33, GLB packet board, Ringo Ranger antenna, and a KLM amplifier. (80w)  
 Coverage: Through packet links, about 600 miles in any direction. As more digipeaters come on line, linking to most of the country is possible.  
 Trustee: Bob McCormick  
 Other: This located in Agawam at the moment and has been in service two months.

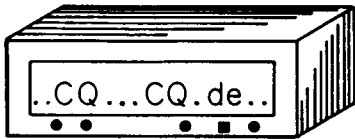

The KAIKPH repeater system will allow you the ability to choose the 10m frequency pair you desire via a touch tone pad. This kind of control demonstrates the ability to select an auxillary link and choose its operating characteristics. For example, you could sit in the living room of your house and using a HT access the system, choosing a free 10m frequency on the 10m link. You can call CQ and even work DX via the cross band link. You can see that the possibilities are only limited by your imagination.

**Training** The HCRA board of directors has already set a high priority on training, both classes for new hams as well as upgrade courses for those already licensed. The HCRA communications system can provide a resource for the training activities. For example, morse code practice tapes with simulated test OSOs can be generated in conjunction with the courses. The RC-850 repeater controller has the ability to turn on a tape deck at a predetermined time and pipe its audio over the network. Once a week a control operator would have to change the tape for next weeks course!

**Packet** Packet radio provides an error free transmission medium for users who have computers or computer terminal equipment. As packet radio evolves, it is believed that the backbone of the NTS will utilize a nationwide packet radio network. Many clubs and individuals are sponsoring computers that are connected to packet radio - these are typically called PBBS or just BBS - Packet Bulletin Board Systems.



You can connect to one of these systems and leave messages for general viewing or leave a message for another individual. You can also receive messages from others on a BBS. Hank, WORLI, in Westford, MA is the author of the most widely used BBS software which runs on a Xerox 820 computer. WIAW-4 in Newington, CT and WA2RKN-1 in Hyde Park, NY are also running BBS systems. Experiments are now being made where you may leave a message on your local BBS for someone who usually access another more distant BBS. During the late evening hours, when activity is light, the BBS system will connect to the more distant BBS system and relay the message. As you can see, the ability to route traffic and other messages is close to a reality.

An HCRA sponsored BBS would allow HCRA members to leave messages for each other and also provide another means of distribution of HCRA information. As packet radio continues to develop the groundwork would already be in place to support an NTS gateway as well as offer high speed communications links between greater Springfield and other large cities.

Summary

By no means is this a finite nor definate list of the features of the HCRA sponsored communications system. In fact, one of the greatest roles the HCRA membership would perform in the oversite of such a network is the generation of ideas; not only by the board, but by and for the needs of the membership and the community they serve.

Obviously the kind of system we describe does not just occur overnight. In fact, the coordination and implementation of such a system on a volunteer basis is a large task. We believe that the HCRA's agreement with the trustees of the various facilities available is the first step toward the implementation of such a system.

The HCRA will initially lease the existing facilities for \$1.00 a year from the trustees for a two year trial period. Future funding for the systems will be controlled by the board of directors. Please note that at this time we are not debating how future funding will occur or will be distributed. We are only laying the groundwork for that activity. A membership application is enclosed. The incorporation of a new repeater group structure will not alter nor affect the current membership of the HCRA. Dues and membership in the Repeater subgroup shall remain optional and totally separate.

KAIKPH-2 SPECIFICATIONS

Frequency: 449.175 output  
 444.175 input  
 Mode: FM  
 Equipment: RCA Series 500, Super Station Master Antenna, RC 850 Controller, links to 6 and 10 meter repeaters.  
 Coverage: Not on the air yet. Should be very good once it is installed at its' final location.  
 Trustee: Bob McCormick  
 AC1T (6)  
 10 meter Trustee asked not to be listed.  
 Other: This is assembled and being tested. Programming of the RC 850 is completed.

MORE NEXT MONTH!

HOW AND WHY: THE REPEATER GROUP...

Purpose

To support state-of-the-art communications technology, to advance amateur radio, improve the technical aspects of the communications arts, to support emergency communications, disseminate information of interest to radio amateurs, to promote and improve the technical skill levels of radio amateurs.

Organizational Guidelines

The present Hampden County Radio Association shall collect all dues, disburse funds, hold fund raisers, publish a newsletter, recruit members, hold meetings, and anything else deemed appropriate and necessary to support, maintain and improve the repeater group and their facilities.

The repeater Trustees shall maintain and upgrade their facilities to reflect the state of the art in communications, prepare technical status reports on their machines, document any monies spent, train others in technical aspects of repeater setup and operation, and help recruit new members.

Dues and Memberships

Dues shall be set by the HCRA Board of Directors. The present memberships shall be maintained intact and shall be wholly separate from the repeater groups. The classes of membership are explained on the membership application.

Repeater Utilization

Maximum use of the machines is to be encouraged. Linking with other repeaters (not necessarily ones in our club!) and linking to other bands will be implemented. Paging of hams over the repeaters will be part of the system. PL service under control operator command will be available for use when situations arise where other repeaters or jammers become a problem.



WALZEV is the proud Dad of a beautiful baby girl... HCRA sponsored licensing classes going great guns at Agawam High School! Contact Art, W1KK at 786-9115 to help out...MTARA Flea Market is March 3rd. Contact N1CDR for more information...W1LRWU and K1FO are organizing an EME contest for 70cm and up...Are any club members involved in ACSSB work? Let ZB know...On the DXCC list- K1DFC, 335; W1ESN, 312; W1EMN, 302;...W1PUX is getting married in May... K1FO has 22 states confirmed for WAS on 1 1/2 meters. W1HDQ has 13 confirmed...K1BW took third in the U.S. in the IARU Radiosport contest! K1KI (multiop) took 7th...K1APR busy designing bigger and better VHF amplifiers...W1PGT received a special award from the club for his support of Zero Beat. Thank you, Jerry! ...W1CJK is the sponsor of an OSCAR 10 orbit!.

Phone patches with advanced features shall be installed. Time signals, weather reports, automatic playback of net announcements, ARRL bulletins, etc, etc will be a integral part of the system. State of the art DF-ing ability might be built in, with telemetry reporting of the bearings. Reduction or elimination of kerchunking will be built into the machines.

Possible nets we could have:

- |                     |                     |                     |
|---------------------|---------------------|---------------------|
| ARRL Bulletins      | DX'ers net          | Traffic nets        |
| Packet radio net    | RTTY net            | EME User's net      |
| Morse code training | Licensing-Technical | Weather net         |
| ARES-RACES nets     | TRN capability      | PACSAT linking      |
| AMTOR capability    | ATV nets            | VEC Exams coming up |
| HCRA club net       | Trader's Net        | OSCAR net           |

Other clubs could hold informal nets  
Hamfest-Misc info on ham activities in our area  
Satellite linking via the repeater

It would be also nice to take advantage of the ability to use tape recorded messages, i.e. a member types in a touch-tone command and hears the RTTY User's Net announcements played back on tape.

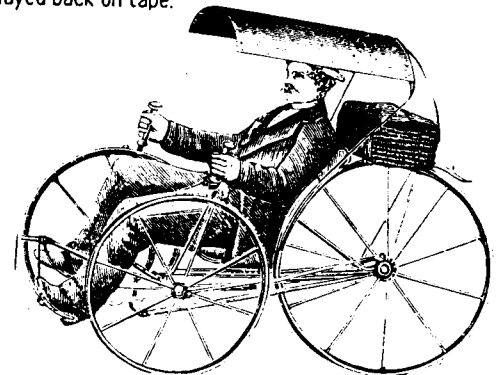

TRY SOMETHING

NEW!!!!!!

Dear Zero Beat,

Just a short note to let you know that "Zero Beat" is arriving Ok down here in Florida. I look forward to each issue.

I didn't operate during the VHF contest as I didn't have the antennas up yet. It'll be several months before I'm ready to go. I did hook up my 40 meter inverted-V to the six meter rig and listened to the few locals that were on. My best "signals heard" was at the end of an opening on 1-13, 0130-0200 Z. Here's some of the calls comming in: W1VD, 55-59, W1NY, 55-58, W1ZNT, 54-57, A1T, 55-57 and K1TR, 55. Hearing the W1NY brought a tear to the eyes! Conditions were good enough here, (Grid EL97) that 10 watts and a good beam would make it. Next January, look for me on six!

I hope the HCRA had a successful contest. Will be watching for the results in ZB and QST. Doesn't seem to be any club effort in this area for the VHF contest. Heard only about a dozen hams on in the Vero Beach area.

I joined the local radio club. They have a club bulletin but its nothing compared to ZB! (copy enclosed) Guess that's about all from Florida. Weather has turned cool, 40' at night, and 60-65' days. Please pass my 73's to one and all. I do miss the old gang.

73, Bob Little, W1WLE/4



CQ DX

by  
W1DGJ

page 7

CLIPPERTON: Starting April 3 for one week ... THAILAND: radio ban lifted January 16th, country's King has been heard on Bangkok's two meter repeater ... MOZAMBIQUE: C90A active on 20 SSB from Maputo ... DESECHEO: March 7-12 by the Texas DX Society ... BOUVET on again, off again, now on again, 3Y4CC starting February 26 by LA4CG ... NEWINGTON: DXCC Honor Roll deadline is end of March ... NAVASA: 6Y5NR DXpedition April 4-9 ... CAMBODIA: XU1SS QRT due to Vietnamese shelling of Ampil village ... NEWINGTON: Honor Roll plaques now available ... RUSSIA: Special call signs starting with E commemorate 40th anniversary of World War II's end, stations signing /R are veterans of that war ... CHINA: Six stations now operating ... CYPRUS: ZC4MR on 14.255 at 16Z ... MARION ISLAND: ZR6AOJ to start this month ... NEWINGTON: Dx phone contest March 2-3 ... SOUTH GEORGIA: possible activity March 7-9 ... BURUNDI: 9U5JB on 3.775 at 04 weekdays ... KERGUELEN: FT8XB on 14.180 at 19Z most days ... RODRIGUES: 3B9CD until mid February ...

160 METERS: MONACO 3A2UA 1.841 06Z ... ANDORRA C31OF 1.832 23Z ... I.T.U. GENEVA 4U1UN 1.825 00Z ... ST. VINCENT J88AQ 1.824 03Z ...

80 METERS: NIUE ZK2IK 3.796 12Z ... GABON 3.503 04Z ...

40 METERS: DJIBOUTI J28EI 7.006 04Z ... BOTSWANA A22ME 7.087 02Z ...

20 METERS: INDIA VU2NBC 14.195 14Z ... POLAND SP7EWL 14.179 15Z ... MAYOTTE FH4AA 14.173 17Z ... TANZANIA 5H3BH 14.157 19Z ...

**DEAR CQ DX:** I worked ER3A in a pile-up but can't find the prefix in the ARRL's country listing. ANSWER: Many other countries like the U.S. are coming up with new prefixes. Look in the last pages of your log for the Table of Allocations of International Call Signs. Prefixes ERA through ESZ are allocated to the U.S.S.R. Incidentally ER3A is located in Moscow!

### SILENT KEYS

We regret to inform the membership that several of our brothers are now silent keys. N1AJZ, Pat Foley, and WB1GVS, Larry Fournier both died suddenly. Pat was a quiet hard worker in the HCRA and volunteered for jobs, that just got done. Larry was honored for his work in severe weather emergencies last year at a club meeting. Jim McDonald, WA1UQV, past president of the MTARA, who was very active in the PVARA, also died. Jim was active on HF/VHF and RTTY. These hams friends are missed by everyone.

BE  
CHALLENGED!  
JOIN  
THE  
HCRA!!!

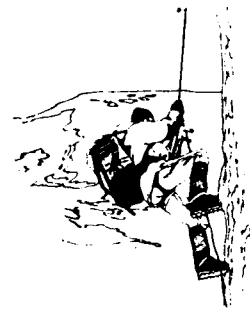

## We Need Volunteers

To help with the ongoing licensing classes at Agawam High School on Tuesday nights! Can you

teach one class, one night? Contact Art, W1KK at 413-786-9115!

### "Quick As A Wink" Printing & Sales Co



Printing • Copying • Addressing  
• Specializing in Newsletters •  
Also Business Cards • Tickets • NCR Sets  
What Else Have You?  
• Free Parking at Our Door •

FRANK H. KOZAK      ROBBIN J. KOZAK  
573 Union Street West Springfield, Ma. 01089  
TELEPHONE (413) 736-8184

W1HGJ/R SPECIFICATIONS

Frequency: 426.25 output  
439.25 input

Mode: Amateur Television (ATV)

Equipment: Homebrew gear with commercial modules.  
Homebrew antenna,  
10 watts out.

Coverage: Unknown, should be about 25 miles.

Trustee: Chet Kruczek  
Bob Gadbois

Other: This is located atop Wilbraham Mountain. It is undergoing tests and has been on the air for a month. You can receive the pictures with a \$4.00 UHF TV tuner from Radio Shack attached to your television.

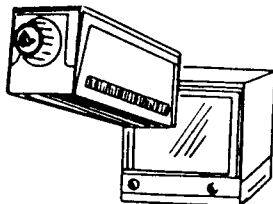

LICENSE TESTING

The Hampden County Radio Association will host its' next ARRL-VEC exam session on Saturday, May 18th at 9 a.m. Location is the Hampden-Wilbraham Regional High School, 621 Main Street, Wilbraham, Mass. Exams for all licenses will be held. Send \$4.00, a form 610, and a photostat of your present license to:

YORKE PHILLIPS  
235 AMES ROAD  
HAMPDEN, MA 01036

Before the cut-off date of April 18th.

HAMPDEN COUNTY RADIO ASSOCIATION FLEA MARKET

Sunday, May 5th West Springfield Lodge of Elks, Morgan Road, West Springfield, MA

9 a.m. to 3 p.m.

\$1.00 Admission

Tables: \$3.00

No Reservations needed!

For Information:

WA1ZKT 413-568-8291

WA1EYF 413-596-8216

Paid Advertisement

**RG-8A<sup>U</sup> Coaxial Cable Sale**

A limited amount of this high-quality foam-core RG-8A coax is now on sale. Some local stores have been selling poor-grade cable for 37¢ per foot! Our coax is brand new, with 96% shielding. Here's your chance to save some money and get better performance.

Price: 500 foot roll, ~~25¢~~ per foot

100 foot lengths, ~~27¢~~ per foot

We'll bring your cable to the next HCRA meeting. You can order over the phone, but there is only a limited amount, and prepaid orders will be taken care of first.

Mail to: Jeffrey J. Duquette, K1BE  
P.O. Box 346  
Southwick, MA 01077  
Phone: Day 413-730-3253

Make checks payable to  
"Jeffrey J. Duquette"

Evenings (Before 9 pm!) 413-569-6739

MTARA FLEA MARKET

Sunday March 3rd Knights of Columbus Hall 460, Granby Rd., Chicopee, MA

8 a.m. to 4 p.m.

\$1.00 Admission

Tables: \$8.00

For Reservations:

413-562-1027

WANTED: The following magazines for my senior project: Ham Radio...June '72, 73...Apr., May 1977.

Please help! Karl Wittier, WB1PNK, 53R Park Lane, Springfield, MA

-FOR SALE-

Drake MN 4C Antenna tuner "matching network", Mint condition. \$40.00, 413-786-2556, Jack WA1YYK

-FOR SALE-

Kenwood TS 520 with CW Filter and Manual-\$325.00

Wilson Systems 1 5 EL Triband Antenna-\$100.00

Both in very good condition.

Russ KA1GIP 413-467-3425

Order form

Length in feet \_\_\_\_\_ Name \_\_\_\_\_  
 @ \$27.00 per 100 feet = \$ \_\_\_\_\_ Call \_\_\_\_\_  
 500 foot roll(s) @ \$125.00 = \$ \_\_\_\_\_ Phone \_\_\_\_\_

*COD, or enclose check! We reserve the right to sell to cash customers first*

Loss in db per 100 feet

TYPE	IMPEDENCE	3.5 Mhz	7 Mhz	14 Mhz	21	28	50	144 Mhz
RG 8/U	52 ohms	0.3	0.45	0.66	0.83	0.98	1.35	2.5
RG 8 A/U	"	0.25	0.36	0.53	0.67	0.80	1.1	2.0

Velocity factor of the RG 8 A/U is .81



# HAMPDEN COUNTY RADIO ASSOCIATION

## Membership Application

### REGULAR MEMBERSHIPS

FULL MEMBER \$9.00 PER SEASON

This class is open to any licensed radio amateur accepted into membership by the Board of Directors. The right to vote, hold office, receive the club newsletter, and all other privileges are included. NO REPEATER PRIVILEGES ARE INCLUDED IN THIS MEMBERSHIP!

ASSOCIATE MEMBER \$9.00 PER SEASON

This class is open to anyone interested in amateur radio, but who does not hold an amateur radio operator's license. They will receive the club newsletter, but may not vote nor hold office. NO REPEATER PRIVILEGES ARE INCLUDED IN THIS MEMBERSHIP!

FAMILY MEMBERSHIP \$14.00 PER SEASON

Any number of FULL or ASSOCIATE members in one household. The club newsletter is mailed to only one address.

### REPEATER MEMBERSHIPS

REPEATER MEMBER \$10.00 PER SEASON

This class is open to licensed radio amateurs accepted into membership by the Board of Directors. ALL repeaters affiliated with the club shall be available to these members. Repeater members may NOT vote, hold office, and will only receive the club newsletter if they pay an additional fee. Repeater members' dues are used to support the repeaters sponsored by the club. Repeater members may optionally earmark their dues for one specific repeater.

FAMILY REPEATER MEMBERSHIP \$15.00 PER SEASON

Any number of REPEATER MEMBERS in one household.

CLUB NEWSLETTER \$5.00 PER SEASON

This option is available for those Repeater or Family Repeater members who would like to receive ZERO BEAT but are not Regular HCRA members. DO NOT CHECK THIS BOX IF YOU ARE A REGULAR, ASSOCIATE, OR FAMILY HCRA member as ZERO BEAT is included with those memberships.

The club season runs from the first of September through the annual meeting in June. Meetings are held monthly at the Feeding Hills Congregational Church. The November meeting is the auction and the May meeting is the flea market. Other meeting topics vary, covering all aspects of Amateur Radio. The club's award winning newsletter, ZERO BEAT, is mailed to regular club members monthly. Volunteer examinations through the ARRL program are regularly scheduled along with license classes from Novice to Extra. The HCRA club station, WINY, is active in many operating events. The HCRA sponsors state of the art communication facilities covering the greater Springfield area with ATV, packet and FM repeaters operating on 10m, 6m, 2m, and 70cm.

The following information regarding your interests is optional:

Please CIRCLE all that apply:

DX	Contests	VHF	ARES	HF
RACES	OSCAR	Traffic	Repeaters	
FM	SSB	CW	ATV	Packet
RTTY	SSTV	FAX	AMTOR	Experimental

We always welcome your comments. Feel free to express yourself here:

NAME: \_\_\_\_\_ CALL: \_\_\_\_\_  
 ADDR: \_\_\_\_\_  
 CITY: \_\_\_\_\_ STATE: \_\_\_\_\_ ZIP: \_\_\_\_\_

Please CIRCLE one choice for each question:

ARRL Membership?	NO	YES	LIFE
License Class?	Novice	Tech	General
	Advanced	Extra	Studying

Dues enclosed: \$ \_\_\_\_\_ Donation: \$ \_\_\_\_\_

Your much appreciated donation is tax deductible!

FOR OFFICE USE ONLY

Accepted: \_\_\_\_\_  
 Rejected: \_\_\_\_\_

Return to:

Hampden County Radio Association  
 P.O. Box 482  
 West Springfield, MA 01090

FIRST CLASS

ACIT E Y

Hampden County Radio Association  
c/o Jeffrey J. Duquette K1BE  
P.O. Box 346  
Southwick, MA 01077

# CALENDAR OF EVENTS

- Feb 26th Novice course, Agawam HS
- March 1 Friday HCRA March Meeting  
Amateur Fast Scan TV - Live and in color...
- March 2-3 \*\*\* ARRL DX Context - SSB \*\*\*  
Sat-Sun The challenge continues...
- mar 3 flea market- Mtara (N1CDR)
- April 12 Friday HCRA April Meeting  
NASA space suits - how they are designed and built for use on the Space Shuttle.....you won't want to miss!
- May 5 Sunday HCRA Spring Flea Market  
West Springfield Lodge of Elks
- May 18 Saturday HCRA & ARRL - FCC Exams  
Wilbraham, MA
- May 19 Sunday NOBARC Flea market  
American Legion, Route 9, Dalton, MA
- June 7 Friday HCRA Annual Meeting  
Awards Ceremony
- june 7-8 vhf contest
- June 22-23 \*\*\* Field Day 1985 \*\*\*  
Sat-Sun HCRA field day WINY club station  
Western Mass Law Enforcement Academy (ACIT)  
and HCRA field day WITM  
Middlefield Fair Grounds, Middlefield, MA (WA1ZKT)

## ARRL Exam Sessions registered as of 31-Dec-84

The following is a subset of the ARRL VE scheduled. In all cases you must send a check for \$4.00 payable to ARRL/VEC with a completed FCC form 610 and a copy of your present license to the indicated contact by the deadline date to be accepted for an exam session.

Session Date: 20-Apr-85 Deadline: 21-Mar-85  
Fairfield ARA, Fairfield CT  
Contact: Robert Kalustian, WA1DVR, 36 Columbia Rd., Arlington MA 02174

Session Date: 18-May-85 Deadline: 18-Apr-85  
Fairfield ARA, Fairfield CT  
Contact: Robert Kalustian, WA1DVR, 36 Columbia Rd., Arlington MA 02174

*Hampden County Radio Assn., Springfield MA*  
*Contact: Watch Zero Beat for info!* If you have been thinking of upgrading new sessions are being scheduled every week. Contact the ARRL for updates to the above list. The HCRA plans to sponsor exams as the demand indicates. With exams also being offered by clubs nearby we think that three or four times a year should do. Let us know your feelings! Contact any board member. And good luck on that upgrade!

