

ZERO BEAT

HAMPDEN COUNTY RADIO ASSOCIATION, INC

SPRINGFIELD, MASS

MARCH 1984

ARRL AFFILIATED, 36th YEAR

NEXT MEETING:

FRIDAY MARCH 2nd

Feeding Hills Congregational Church,
Feeding Hills, Mass

7:30 pm

**HOW TO CONVERT YOUR OLD CB RADIO OVER
TO 10 METER FM!**

ACIT will show us how to do it, what's available on the band, and why you might want to do it yourself.

ALSO: ARRL DX logsheets! Bus Tickets!



EDITOR'S COMMENTS

Well, gang, I hope you've been enjoying ZERO BEAT. Today has been one of those (!), when the printer keeps jamming and I can't get the pages out of the computer. If you hear someone has been admitted to the hospital with a printer stuck on their foot, don't wonder who it is.

I was struck by the product review in the February QST, page 43, on the RC-850. If you can recall an article I did a few years ago on what a repeater should be able to do, you'll know that they designed this gadget with me in mind! I still think we should form a Hampden County Repeater Association, and design a repeater that is the leader of the pack.

If you've written an article for ZERO BEAT and start to get strange fan mail from across the country, the reason why is that I've been uploading articles into the COMPUSERVE computer information service. Response has been very good, and these are being re-printed in club newsletters across the country.

If you've promised or have been working on a ZERO BEAT article, let's finish it soon! We only have three issues left to go, and the June ZB is almost filled up.

73,
K1BE

%%%%%%
**DUES ARE \$8.50 PER SEASON. (Sept-June) MAIL TO: Greg Stoddard, N1AEH,
1500 Mapleton Ave, Suffield, CT 06078**

FOR THE BETTERMENT OF AMATEUR RADIO.

A local company has generously decided to donate sixteen GE Procline radios which are being phased out of service. Their only stipulation was that they be put to use for the betterment of amateur radio. These radios are complete with power supply, all cables, manuals, etc and are convertible to six meter operation. They use a 6146 final tube, have a single crystal channel, and put out 35 watts.

The Board of Directors has decided to sell the radios to club members only, on a first-come, first served basis, for \$15.00 each. (Fifteen dollars) The club treasurer will collect the money and assign the radios. Note that we have to receive your check, no phone calls to reserve a radio! The money generated by this sale will be used to further the Amateur Radio Service. Right now we are not sure exactly how it will be spent, but it will be for worthwhile activities.

TIDBITS

NIABJ won the VIC-20 at the club meeting in February. FB, Bob... The HCRA Field Day will be held in 1984 at the Middlefield Fair Grounds. More on this in a later issue... WBLETS will be bringing samples of the new Belden coax reviewed in QST. The cables are designated by the numbers 9913, 9914, and 9915... WBIABF is doing the primary sort for the QSL Bureau right now... The annual HCRA banquet on June 1st will have as its' theme: Salute to the QSL Bureau! All past and present sorters will be invited reminisce... KALT made DXCC... WB1GLX is new Hampden County EC!

CUSTOMIZED TV BROADCASTING COMING! (From W5YI Report)

Nolan Bushnell is perhaps the most noted name in sophisticated innovative digital black boxes. He has long messy hair, a beard...and thinks at a level that is years ahead of anyone else. You probably know him best as the inventor of "Pong", the first videogame that simulated tabled tennis introduced a scant 12 years ago! Bushnell went on to found Atari which he later sold to Warner Communications. The rest is history.

Bushnell has gone on to other things. He now heads a firm by the name of Catalyst Technologies. Without fanfare, he is quietly showing potential investors, production engineers and broadcasters another black box that he has come up with... a futuristic smart black box called ACTV. It's pronounced "Active" but a better name would be "interactive."

It promises to allow the public to select what they want to see on TV.

That is, variations of the same programming! ACTV will also allow broadcasters to "preselect demographics and psychographics" and direct their advertising and programming to a specific persuasion.

CIRCULAR ANTENNA POLARIZATION- PART II

By Art Zavarella, W1KK

The first part of this article, HOME-BREW 3-D TWINS FOR OSCAR 10, appeared in the October, 1983 issue of ZERO BEAT.

Just to review a little, let's recall one of the earliest QST articles on this subject, in July of 1962. Scott W4VSN and Banta, W4SGI, described a helical antenna they made from data provided by the well-known Dr. Kraus, W8JK, in September, 1949. The frequency of interest was 1215 Mhz, and the antenna was wound on a 3 inch diameter form, (Morton Salt box!) with 1/4 inch, thin-wall copper automotive tubing. They made a total of ten turns, then elongated it to 24 inches, with an aluminum dish as a reflector. Here's what the authors said about the results: "The single helix of 10 turns is about 4db better than our best single Yagi, due to the uncritical nature of the helix."

Other points brought out in the article are that if wound like a right-hand screw, it will be Right-Hand Circular, (RHC), whereas if wound in the opposite, counter-clockwise direction of a left hand screw, it will be Left Hand Circular. (LHC) See figure One.

Either RHC or LHC work equally well with horizontally or vertically polarized waves, with a loss of only 3db or less due to some amount of polarization shift on most paths, especially over rough terrain.

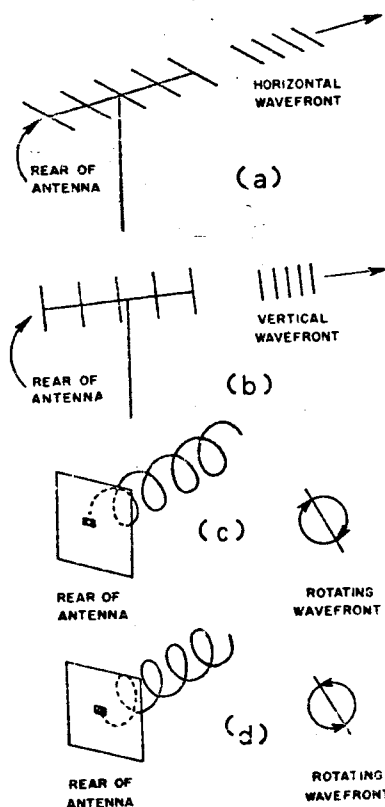

Fig.1 - Types of polarization. (A) Horizontal polarization. (B) Vertical polarization. (C) Right-hand circular polarization. (D) Left-hand circular polarization.

The next QST story of interest appeared in April of 1959, titled "TURNSTILE FOR TWO" by L. Campbell, W1CUT. The article was sub-titled "A Horizontally Polarized Omnidirectional Mobile Antenna". Although the word circular or circularity does not appear in the article, as pictured, it shows two dipoles in the same horizontal plane fed a 90° phase difference with a quarter wave length of RG-59U. This configuration, in the light of later technology, gives the antenna circularity, and since it is pointing straight up, also makes it omnidirectional! An important contribution is Campbell's use of a "Q" section of quarter wave RG-58A/U to match the 35 ohm dipoles to the RG-59/U "70 ohm" feedline of any length.

Then in January of 1973 QST, KH6IJ introduced us to crossed Yagis Gamma matched and fed 90° out of phase in order to obtain

ACTV is based (naturally) on new sophisticated microprocessors and TV production methods. It is interactive as far as the consumer is concerned but is really a one-way transmission of multiplexed signals via normal transmission methods. What makes it unique is that viewers (or broadcasters) will be able to choose from the various multiplexed signal options.

A viewer, for example, would be able to choose from three other views of the same play during a football game...sort of like custom replays. As many as 16 different commercials could be transmitted during a single commercial break but the viewer would see only what the black box selects. You can even choose the "rating" of the commercial - from PG to X! (If no choice is made, you get the tame version).

Some individuals will contract to allow their black box selections to be "dumped" to ascertain demographic and psychographic individual and community profiles - ten dollar words that indicate who you are and what you like. Advertisers will pay more for custom audiences that are more likely to buy their products.

Among program concepts on the horizon are interactive game shows, soap operas, adult drama, personal help shows...you name it! Only the imagination limits the possibility of ACTV. An exercise show is already in production whereby you choose the body part that needs shaping! And the TV will remember your needs for the next exercise session!

News programs can be set up by order of interest... you can choose expanded segments... go right into the sports. And the microprocessor gets "trained" by your previous selections. Once "programmed" by your television viewing it will be adapted to you and will be completely unlike anyone else... even though you are listening to the same channel! Wild? You bet! But so was "Pong" back in 1972! (From W5YI Report, downloaded from COMPUSERVE)

TIDBITS FROM PAST ZERO BEATS-1967

W1CTQ accepted into club membership...W1NY, W1JWV, W1TIX, W1GQP, and W1IC heard on two meters...K1PKZ's 10 meter beam bent in a windstorm...W1ALL, and W1IUB running a training course for Southwick CD...K1NWF operating SV0WKK in Greece...W1QWJ and K1RPB gave a talk at the Swampscott Convention on homebrewing equipment...W1NY operating from his summer home in Wellfleet...W1MNG (now W1KK) instructor at Westfield State College...W1STR (now N1PF) new SCM...W1BVR thanked for his many years of service to amateur radio...W1DNB instructing Boy Scouts in code...K1FUA is Zero Beat's editor...K1JNC, W1DZZ, W1GJO, and K1PKZ journeyed to EXPO '67 and got to operate VE1XPO...W1GZO accepted as a member...Club officially becomes the W1-QSL Bureau!...

circularity for ^ucontrasting shift in polarization with satellite and space signals. He also mentions the unfortunate discrepancy in definition of polarization sense: Physics- clockwise rotation of an approaching wave is called "right-circular polarization". IEEE, (including ARRL, AMSAT)- use the term "clockwise circular polarization" for a receding wave. Henceforth, we will use the latter, looking at the antenna from the rear or behind the reflector.

Shortly after the KH6IJ article came the TR, or Turnstile Reflector in the September, 1974 QST, written by Davidoff, K2UBC. He is now recognized as one of our leading OSCAR experts. Davidoff designed this easily homebrewed array as an inexpensive alternative to the sophisticated tracking and steering rotators, and high-gain antennas. K2UBC uses the same crossed dipoles with phasing line and matching sections as WLCUT did with his mobile turnstile, but in addition incorporates a wire-mesh reflector to obtain the desired null-free, balloon pattern. This also has the important improvement of less fading on account of circularity. See Figure two. This antenna enjoyed considerable popularity in connection

with the Space Shuttle. It was covered in QEX issue #19, by Jerry Hull K1TD of the ARRL. The complete design was featured in the October '83 issue of ZERO BEAT, and many club members found out how easy it was by actually making one!

Now we get into some serious work again with OSCAR 10 and circularity confusion in the commercial field as well. We have been doing antenna tests using known circularity by building helix antennas, and comparing them to the commercially built designs by KLM and Cushcraft, to see what sense the antenna really has-LHC or RHC? Next article we'll offer a few words on what we've found- and you'll be surprised!

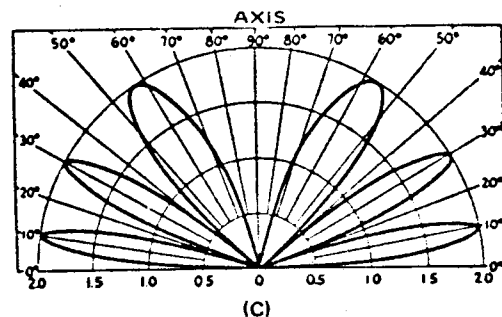
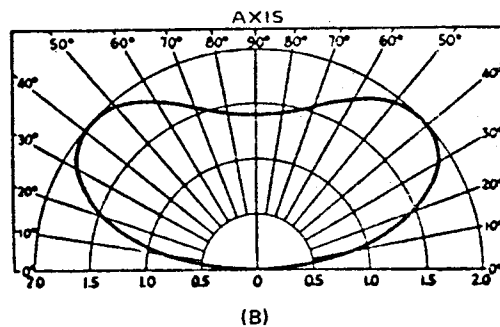
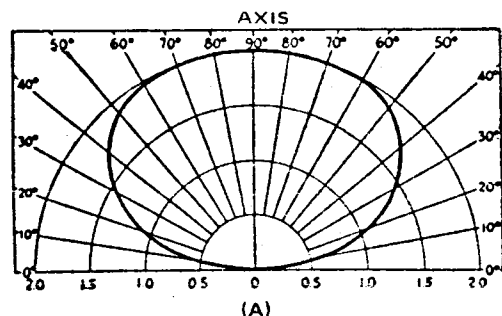

Fig. 2 - Elevation patterns for dipoles mounted over a ground plane. Pattern A is for spacing of 0.22 wavelength, B is for 0.37, and C is for 1.5 wavelength spacing.

"Quick As A Wink" Printing & Sales Co



PRINTING & COPYING

573 Union Street West Springfield, Ma. 01089

TELEPHONE (413) 736-8184

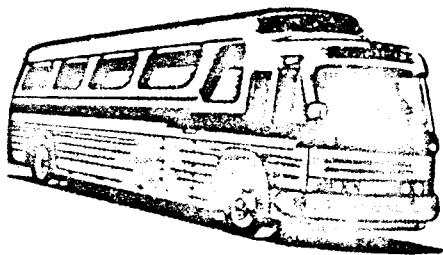

CHARTER BUS TO THE ARRL NATIONAL CONVENTION

Saturday, July 21, 1984

Leave Springfield at 7, arrive NYC, 10, Leave 10PM. This will give everyone a chance to attend the banquet, and meet Owen Garriot, W5LFL. Here's how to get seats:

Until June 1st, 1984, bus tickets will be sold only to members of the Hampden County Radio Association. Members tickets- \$12.00, ticket for a spouse, -\$13.00 (If spouse is a member, apply \$12.00 rate.)

After the June 1st Club Banquet, tickets will be sold to anyone, at \$14.00 per ticket. If you are not on the club membership list and you send in the money early, you will be on a waiting list for seats, based on your postmark. Money will be refunded if all seats are not sold by July 1st, 1984. **THE BUS SEATS 49 PEOPLE, DON'T WAIT 'TIL THE LAST MINUTE!** Door prize to be awarded on the bus.

TO ORDER: Send a check made payable to the HCRA, with your name and address. Include an SASE, please. Use the form below, if you want.

Mail to: Jeffrey J. Duquette, P.O. Box 346, Southwick, MA 01077

NAME _____ CALLSIGN _____

NAME _____ CALLSIGN _____

MAILING ADDRESS _____

AMOUNT ENCLOSED: (street) _____ (city) _____ (state) (zip) _____

Members \$12.00 Member's Spouse \$13.00 ALL TICKETS AFTER June 1st: \$14.00

Note: The club membership list is for the hams trying to earn the "Worked-All-Hampden-County" award. The intent of the award is to publicize the club by getting you to ask other hams if they are club members! So, don't be shy about doing that.....

WANTED: 220 FM transceiver, can be crystal controlled or synthesized, hand-held or a base rig. Please contact John Balboni, AC1T at 786-2438.

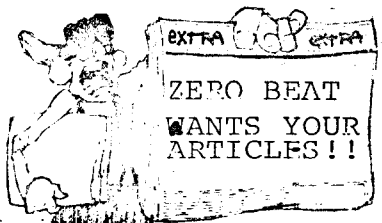

CLUB MEMBERSHIP FEBRUARY 1984

GARY NORMAN	AB11	ED FONTAINE	KAIKEN	GARY POTTS	WAIECK
JOHN BALBONI	AC1T	DOB MCCORMICK	KAIKFM	ALAN RICH	WAIEPH
OLIE PASSIORD	AK1C	JIM PLATINITS	KAIKRF	STEVE NELSON	WAIEYH
ALLAN LETO	ALLAN			VINCE FALARDEAU	WAIGOV
		V. KURIAN THOMAS	KAIJW	PHIL GORMAN	WAIGYV
JUERGEN HALJER	DK1TH	JIM PARKVART	KBIY	KEVIN STROMGEN	WA1JWJ
JEFF DUKETTE	K1BE	ROBERT ROY	NIADJ	ALBERT TILBE	WA1KUD
ROBERT GRAVEL	K1GUB	GREG STODDARD	NIAEH	AL WASHORN	WA1LIS
YORKE PHILLIPS	K1BKE	NORMAN COURNOYER	NIAFY	GERRY GRIFFIN	WA1POT
FLORIAN DIRONA	K1EPI	PAT FOLEY	NIAJZ	ED OLLDERO	WA1PSS
STEVE POLLISHEN	K1FO	JOHN J KOHLER	NIASQ	DAVE WALKER	WA1POB
JOHN SHERMAN	K1OTE	MARVIN YALE	NIADR	BRUCE FELPER	WA1PJK
LAURENCE LAMOEVIN	K1G1U	ALBERT DRAKE	NIADR	FRANK POTTS	WA1RAJ
W H TELTEL	K1HNI	SARREN SWATT	NIQRO	DON FARLEY	WA1SDY
IC NORMAN J PEACORK	K1JJK/JK/JW	FRANDY JOHNSON	NIJFJ	AL JACKOWSKI	WA1SPM
DICK DIEFENDERFER	K1JUL	NORMAN P FOREST	NIJFF	PETER BEAUREGARD	WA1SQP
RICHARD A WOLOS	K1KEQ	MR/MRS RODOLICE	NIJFR/NIACS	EDGAR OVERSTREET	WA1UUV
MARVIN MCCORKEY	K1KAL	EDWIN STROM	NSDKA		
JOHN SHEEHAN	K1KJC	DICK HANER	NSDQU		
MR AND MRS YOUNG	K1KNE/K1LOR	GEORGE HUGHES	NIALL	RUDY ZERDECKI	WB1CXC
P CAPUTO/S FOGO	K1PKZ/K1IHH	JIM SPATES	NIARA	GEORGE NELSON	WB1DKM
WILLIAM JACIOM	K1QNY	PERCY NOBLE	NIAYR	BERT SUYDAM	WB1DZT
BOB MAYO	K1SUD	MARVEY HENSCH	W1BVB	RON BEAUCHENIN	WB1ETS
PAUL WIND	K1HVI	WILLIAM MERENSKI	W1BCK	ROE BEAUCHENIN	WB1FYS
FRED STEFANIK	K1AMP	HAROLD R. GRAVEL	W1COP	YOH BELNICKI	WB1FYS
BILL SHANNON	K1DWH	MIKE LUCKIEWICZ	W1DQJ	GEORGE R ATKINS	WB1FJJ
RONALD J. GARACHEKA	K1BFF	KEITH WALKER	W1FAD	RAYMOND BURK	WB1GLL
DONALD HAZZUCHI	K1BEX	AL HILES	W1GQP	ALFRED TEDESCHI	WB1OLZ
FRANCIS DESANTIS	K1CAX	ED TILTON	W1HQD	JACK SANOCKI	WB1OTR
PETER SHAPRAS	K1CDS	JOHN SULLIVAN	W1HMR	DICK CUNNINGHAM	WB1IHW
LEO TOURIGNY	K1CPG	HOWARD CUTTING	W1JWV		
WILLIAM C SAMPLE	K1COL	ART ZAVARELLA	W1KUE		
BOB BROUGH	K1CRX	THOMAS DARRETT	W1KX		
RICHARD BEHERENS	K1GTH	MR & MRS GORDON	W1KUL/W1LOR	ROBERT TIPPETT	WB1IVM
LES PRENTICE	K1DNI	WILLIAM R. PADDEMMINDL	W1LMD	WILLIAM RILEY	WB1VWJ
FRED NADEAU	K1DVI	ROBERT STEPHENS	W1MPL	BILL LUCARDI	WB1VSS
MUREL GOVER	K1IECJ	ROBERT ADOLPHSON	W1MPL	LOUIS S RECHIER	WB1VTK
HARVEY MORSE	K1EES	EDWARD WHITE	W1MPL	JACK LORWOOD	WB1VTK
BILL MC CARTHY	K1ERS	WESLEY J ANDREWS	W1MPO	RICHARD MELBOURNE	WB1VYV
ANNE PASGINO	K1EUJ	ROBERT GADBOIS	W1MPP	STEVE SHORE	WB1ZEV
CLEGGAN L WOODS	K1FDE	WALTER WALCZAK	W1MRC	MR. & MRS. KRESS	WB1ZKT
LARRY SAVDY	K1ODV	PAT GLEASON	W1MRC	MR & MRS MURNANE	WB1APD/WB1E
RUSS LA MONDER	K1GIP	TED WITORSKI	W1MRY	DAVE ISHAM	WB1EPJ
NED CARPENTER	K1GTT	BILL LOWE	W1MTH	DON LEHAY	WB1DWD
ELEANOR GAY	K1GVC	ED FOSTER	W1LTL	KEN NICKOLLS	WB1BZH
ROLAND CHARTIER	K1GVT	RICHARD DOMINGO	W1TTS	MALCOLM J GESNER	WB1CLO/WB1D
LARRY CARLSON	K1HUS	DON JOHNSON	W1UFP		
NATALIE DRAVE	K1IUT	CLIFF JUNKINS JR.	W1UWE		
BOB ARCHAMBAULT	K1JUD	LEO BRODEUR	W1VNE		
ROBERT CHANDLER	K1JEA	ROBERT LITTLE	W1VNE		
JAMES FINNIE	K1JEC	ALFRED PURSELOVE	W1VNI		
DAVID FLYNN	K1KCM	GENT LAM	W1VOP		
KEN GRADY	K1KEN	ROBERT PHOENIX	W1VON		

A SURVEY OF OSCAR STATION EQUIPMENT, Part 1

By Harold Winard, KB2M, and Roger Soderman, KW2U

The successful launch and operation of AMSAT-OSCAR 10 has rekindled an unprecedented interest in communications satellites and the equipment needed to use them. Although a complete system can cost thousands of dollars, it isn't necessary to spend that much to create a very adequate and serviceable satellite station. After a careful appraisal of your current resources, both equipment and financial, the newcomer should be able to assemble an economical, yet potent station.

Many Hams already have major pieces of equipment that can serve well in the satellite station. For example, low-band equipment, either a transceiver or a separate transmitter and receiver, can be hooked to several converters to generate the uplink signal and receive the satellite's downlink. Many hams already have multimode two-meter transceivers and they too can be used to receive the satellite's output.

Other pieces of equipment that might already be on hand or currently in use include an appropriate preamplifier, a small power amplifier, lengths of low-loss coaxial or hardline cable, rotors, and assorted feedline switches.

OSCAR-10 has been performing so well that some equipment may not be necessary. For example, the downlink is quite strong and a good antenna plus an inexpensive preamplifier may be all you will need to receive an adequate signal. Also, the bird's receiver is quite sensitive and a large power amplifier is often not necessary for satellite fun. QRP day has shown that the barefoot output of some rigs, about 10 watts, is often sufficient to work through the two-meter-to-70-cm transponder.

If you must buy or build all or part of your satellite station, what follows is a guide to commercial products currently available. It is by no means exhaustive, and you are encouraged to call or write to all those offering appropriate equipment for more information. Companies, both new and old, are introducing new OSCAR-related equipment each month so check the pages of *Orbit* and other Ham magazines frequently for their names and addresses. Specifications given below are those published by the manufacturers.

The Signal Gets A Boost

There are several options for the amateur looking for a preamplifier. Just which to select depends, in large part, on the type of installation and involves some physical considerations and an honest appraisal of the amateur's financial resources. Although a gallium-arsenide field-effect transistor, or GaAsFET preamp is generally acknowledged to provide superior performance, on-the-air experience shows that quite adequate reception can be had with a less expensive bipolar device.

If the length of coaxial cable between the antenna and the rig is short, say 20 feet, a preamplifier in the shack itself can be a wise choice. Since it hardly ever rains in your shack, no weatherproofing is required and the dc power leads can be short as well. The same holds true for low-loss cable. If the feedline brings the signal to the rig with little attenuation, an indoor preamplifier may be sufficient.

Alas, it is not always adequate to mount an antenna system close to the shack, so often a mast-mounted preamplifier is a necessity. If your antenna is used exclusively for receiving downlink signals, you're in luck. The preamp can be left in-line all the time. Such is not the case for those who must get extra service from the OSCAR antenna system by using it for terrestrial DX work. If a signal is radiated from the antenna, some additional hardware is needed to remove the preamp during transmissions. A set of low-loss external relays are a good choice but a more convenient solution is preamplifiers with integral switching systems. With no muss or fuss, those units switch between receiving and transmitting conditions and protect the sensitive preamp transistor from the relatively powerful surge of rf energy fractions of an inch away.

Current Amateur state-of-the-art is the GaAsFET, a device that offers the combined advantages of a very low noise figure and high immunity to overload. Leading the Advanced Receiver Research (Burlington, Conn.) preamplifier line are the P144VDG and P432VDG, two-meter and 70-cm units respectively (Fig. 1). Both use the MGF-1400 GaAsFET and have been equipped with protection against power-supply transients and destructive gate-voltage charges.

ARR's two-meter GaAsFET preamp sports a noise figure of less than 0.5 dB and offers a gain of 24 dB. The 1-dB compression point is +12 dBm and the 1-dB bandwidth, a wide 7 MHz. The 432-MHz unit is also an impressive performer. For example, it too has a noise figure below 0.5 dB but supplies an adequate 16 dB gain. The 1-dB compression point is also +12 dBm, however the bandwidth is a whopping 40 MHz. For a tidy installation, the preamp, which measures just 2.75 by 2.375 by 0.75 in., can be placed inside the receiver.

But for the best system noise figure ARR recommends putting its preamp at the antenna.

An old hand at commercial preamplifier development, Angle Linear (Lomita, Calif.) has recently introduced a series of GaAsFET preamplifiers for Amateur use. The extensive range includes units for all Amateur bands from 144 to 2304 MHz with some commercial and weather satellite bands thrown in as well. All are housed in rugged irridited aluminum enclosures held together with stainless steel hardware. The signal path finds its way through silver-plated Type-N connectors with gold center pins.

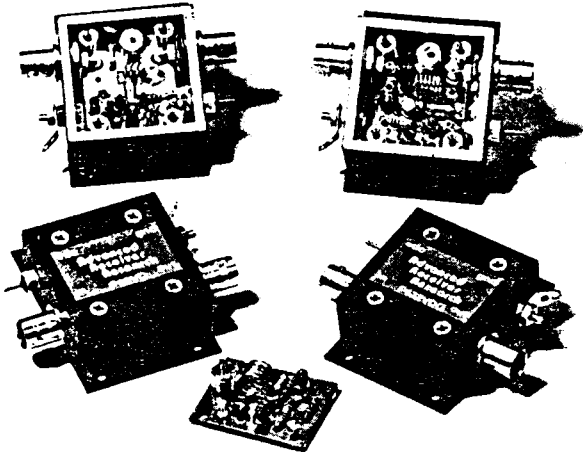

Fig. 1 — Advanced Receiver Preamps.

The two-meter model has a typical noise figure of 0.5 dB and a gain of 23 dB. Common port inductance is part of the amplifier's design for low input and output VSWR (return loss). Also included is a metal-oxide varistor that helps protect the preamp against lightning. An internal voltage regulator offers protection of another type — stable biasing over an input voltage range of 9 to 12 V.

California's Lunar Electronics (San Diego, Calif.) manufactures two GaAsFET amplifiers of interest to satellite enthusiasts: the two-meter model PAG 144 and its 70-cm equivalent, the PAG 432. The former has a claimed noise figure of just 0.2 dB with 26 dB of gain. The 432-MHz model exhibits a 0.5-dB noise figure for 18 dB of gain.

An imported GaAsFET preamplifier, the Kenpro KP 145G, is specifically designed for mast mounting and comes in an appropriate weatherproof case. According to the U.S. importer, Spectrum West (Seattle, Wash.), the unit has a noise figure of between 1 and 1.5 dB and a gain from 12 to 24 dB.

Another imported preamplifier comes from the British company Ambit (Brentwood, Essex, England) and is available from Radiokit (Greenville, N. Hampshire). Designed by Roger Ray and presented as a project in the October 1982 issue of *Radio & Electronics World*, the GaAsFET unit is supplied in kit form. Included in a masthead box are the preamplifier and a pair of coaxial relays that can handle up to 400 W pk-pk. Power for the preamp and the relays is supplied through the same coaxial cable that carries the rf signal.

Value For The Money

The conventional bipolar or MOSFET preamplifier hasn't been displaced by the more expensive GaAsFET types and continues to be a good value for system upgrading. Hamtronics, Inc. (Hilton, New York) offers two types: the low-cost P30 and P432 models and the LNA series of low-noise preamps. The P30 is available for any band from 27 to 300 MHz and uses a protected dual-gate MOSFET. Its noise figure varies from 1.5 to 2 dB, depending on frequency. Gains from 18 to 20 dB are available.

A reliable stalwart of the UHF range, the MRF-901 transistor, is used in the P432 preamp. The unit has 16 dB of gain and a noise figure of just 2 dB. Its 1-dB bandwidth is 50 MHz and it offers 22 dB of rejection for two-meter signals, an important consideration for future Mode-J operation with JAS-1.

The LNA series touts the advantages of the bipolar preamplifier without the problems associated with GaAsFET units. For example, the two-meter LNA-144 offers 18 dB of gain and a noise figure of just 1 dB. Its maker points out that it will tolerate the static discharges and rf overloads that would destroy unprotected GaAsFET types. Hamtronics also offers a 432-MHz version, the LNA-432, as well as HRA Series preamplifiers with integral helical resonators.

MOSFETs and bipolar transistors are the active devices in Advanced Receiver Research's standard preamplifier line. The P144 comes in two models, one with a 1.5-dB maximum noise figure and the other, just 1 dB. The 432-MHz versions have 1.8 and 1.1 dB noise figures. The latter two preamplifiers use bipolar devices and the former two, MOSFETs.

Snaring The Signal

One of the most important parts of your satellite station, and often the most neglected, is the antenna. It must have sufficient gain to receive the satellite's output yet have a broad enough beamwidth to obviate the need for constant pointing adjustments. It also must be sufficiently strong to withstand the rigors of the environment but lightweight enough to be moved by inexpensive rotors.

The actual choice of an antenna is up to the individual but some guidelines can help. In general, linear antennas are not suitable for satellite use. Because the satellite's pointing angle is constantly changing with respect to the user, the ground-based antenna must be capable of circular polarization. Indeed, "the circular advantage" is what KLM Electronics (Morgan Hill, Calif.) claims for its 2M-14C (Fig. 4) and 435-18C

antennas for two-meters and 70-cm respectively. The former measures 12 feet 9 in. long and has 14 elements in all — 7 vertical and 7 horizontal. Rf power is supplied to a folded dipole driven element and, for control of the polarization, a circularity switcher is included. KLM claims 11 dBdc gain for its two-meter antenna and a beamwidth of 48°. The 435-MHz antenna has a gain of 12 dBdc and measures 7.3 feet along the boom. An optional circularity switcher is available.

A new addition to Cushcraft's (Manchester, N. Hampshire) Boomer antenna series is the 416-TB, an antenna especially designed for the OSCAR-10 Mode B uplink. That 16-element model has a claimed forward gain of 12.5 dBd and a 34° beamwidth. The elements are insulated from the boom and the driven elements are T-matched. It joins the previously announced A144-10T and A144-20T two-meter antennas, which have gains of 10.5 and 12.2 dB respectively.

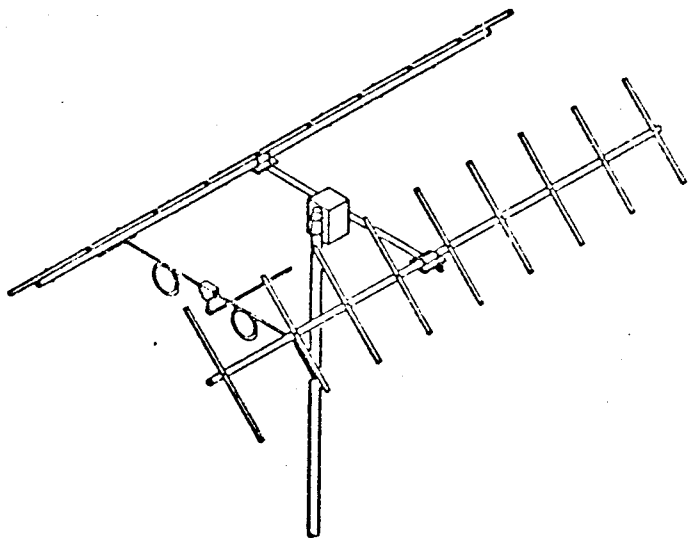

To trim the time needed to get your antennas up in the air, Cushcraft supplies a complete mounting boom for its antennas. Designated A14T-MB, the kit includes a 4.2 foot support boom with a mounting plate designed for use with the popular Alliance U100 elevation rotor. For convenient one-stop shopping, the company will supply you with its OSCAR Pack, Model AOP-1, which includes the 435-MHz antenna, the 20-element A144-20T, and the A14T-MB mounting kit.

Japanese manufacturer Taniguchi Engineering Traders (TET) also includes a satellite antenna in its line, the AX-210N. A 10-element crossed Yagi antenna, the AX-210N sports a claimed forward gain of 14.6 dB. Slightly better performance, 17.5 dB, is attributed to the two-antenna array designated the AX-210NW.

Pointing At The Bird

Much of the equipment used in the satellite station can be found in the well-equipped ham shack but one that cannot is the elevation rotor. Although few types are available, the most popular is also one of the least expensive. The U-100 rotor from Alliance Manufacturing, designed for light-duty TV use, can be mounted horizontally to elevate an antenna. A boom of up to 1-3/8 in. can be accommodated in the through-mast mounting system. However, because the rotor is designed for light-duty work it may not be able to handle large antennas or those covered with many layers of winter ice. Also, the rotor does not have a braking system.

Designed specifically for elevation chores, the Kenpro KR500 lifts even moderately large arrays with boom diameters of up to 1-1/2 in. The unit's control-box circuitry is voltage regulated and provides an accurate indication of antenna position.

Part II of this article will appear in a future issue of *Orbit Magazine*.

Many thanks to AMSAT and their magazine, ORBIT.

A special Note: Advanced Receiver Research mentioned in the above article is the company started by our HCRA member, Jay Rusgrove, W1VD. FB!

DX CORNER (From COMPUSERVE)

=== Coming up:

BY China. By VE7BC in late March on SSB.
 FO Clipperton. By group from March 9 for one week.
 J6 St Lucia. By W2LZX from Feb 10-14. May use J6LCO.
 PJ7 Sint Maarten. By K2KTT from Feb 10 for two weeks for ARRL DX contest.
 SU Egypt. By W4WZE, starting this month for one year.
 ZK1 North Cook. By ZK1MA from Feb 18 to Mar 18, CW/RTTY. QSL ZK1CG.
 SW1ER W.Samoa. By K2FJ from Feb 20 to Mar 6. QSL K2FJ. By DL1VU as 5W1DC from Jan 30 to Feb 29.
 YV0AA Aves. By Radio Club maybe March 1 for 4 days.
 ZD8 Ascension. By VP5RAC soon, and by ZD7HH in April.

=== Reported on:

CP Bolivia. By W6KG/CP6, random on usual DX freqs. QSL via YASHE.
 EL7W Liberia. By N4CVR. QSL K4SE.
 KH9 Wake. By AH3AA/KH9 on 21292 at 2120, 14227 from 0030 to 0200. QSL W1ISD.
 TI9 Cocos. By N1CWH/TI9 on 14235 net at 2330. QSL TI2SLC.
 XU Cambodia. XU1SS on 14335 at 1200 Sunday, 14016 at 1100. QSL JAIHQ.
 ZL8AFH Kermadec. On 7085 at 0830-0930. VK9NS plans unknown.
 3B8CF Mauritius. On 3504+- around 0200Z.
 5X Uganda. By G8GRN/5X on 21162 in EU. QSL G4CTQ.

=== Contests:

Mar 3-4 ARRL DX Phone
 Mar 24-25 CQ WPX SSB

LOGS FOR THE ARRL DX CONTEST WILL BE AVAILABLE AT THE MARCH HCRA MEETING! Good chance to earn your WORKED ALL HAMPDEN COUNTY AWARD!

NEWS FLASH

Jean (K1IJV) and Norm, (K1IJU), will be operating as VK2KBE and VK2KBD starting on March 3 and 4th. Bill and Heather Hall will also be there, but have not received their calls as we go to press! Look for them on 14.295 mhz at 1200Z most days.

SCHEDULE OF EVENTS:

- March 2nd How to convert an old CB to
10 meter FM! (AC1T)
- April 6th Radio Review night; Homebrew
Night (K1BE)
- MAY Annual Flea Market (Not firmed
up yet.) (WA1ZKT)
- June 1st Annual Club Banquet-SALUTE
TO THE QSL BUREAU- Roast Beef
Dinner at the FH Church.

ARRL INTERNATIONAL DX CONTEST

March 3-4 Phone
(Logs available at the March meeting)

FIELD DAY: June 23-24th
Middlefield Fairgrounds, Middlefield, MA

ARRL NATIONAL CONVENTION,
NEW YORK CITY
July 20-22nd
(HCRA Bus Trip on July 21st)

(SUBJECT TO CHANGE)

HAMPDEN COUNTY RADIO ASSOCIATION, INC
c/o Jeffrey J. Duquette K1BE
P.O. Box 346
Southwick, Mass 01077

TO:

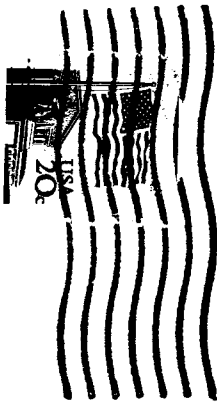

ZERO BEAT
MARCH 1984

FIRST CLASS