

ZERO BEAT

HAMPDEN COUNTY RADIO ASSOCIATION, INC

FEBRUARY 1982

WI QSL BUREAU

SPRINGFIELD, MASS

ARRL AFFILIATED, 34th YEAR

February Meeting

For our February meeting we will have a change of schedule to accommodate one of our speakers. Our original speaker for this month, Gent Lam, WA1CQF who was scheduled to speak on Linear Amplifiers has graciously offered to move to March to accommodate Bill Poellnitz, K1MM. Bill, an avid DXer with experience on both ends of the DX contact will speak on his experiences being a DX station. He will include in his discussion slides and accounts of the Spratly expedition as well as other DXpeditions he has been on. For those who are planning a trip to their favorite DX spot, Bill has promised to inform us of the trials and tribulations of setting up and reaching your DX operating position as well as how to avoid the local artillery.

Bill Poellnitz is an extremely articulate and enthusiastic speaker who will amuse, entertain and educate all in attendance. If you're a DX fan, travel buff, or just enjoy a good meeting our February program can't be missed.

Continuing our program of presenting outstanding speakers, Gent Lam WA1CQF one of our own Hampden County Radio Association family will be on tap in March. More about that next month.

Steve WA1EYF

"Quick As A Wink" Printing & Sales Co.

573 Union Street West Springfield, Ma. 01089

NOTE: NEW ADDRESS

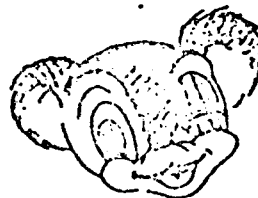

INDUSTRIAL COMPONENTS CORP.

Wholesale Electronic Supplies
2551 Boston Rd.
North Wilbraham, Mass.
Telephone 596-3854

Batteries - Tubes - Electronic Parts

INDUSTRIAL COMPONENTS CORP.

Wholesale Electronic Supplies
2551 Boston Rd.
North Wilbraham, Mass.
Telephone 596-3854

Batteries - Tubes - Electronic Parts

INDUSTRIAL COMPONENTS CORP.

Wholesale Electronic Supplies
2551 Boston Rd.
North Wilbraham, Mass.
Telephone 596-3854

Batteries - Tubes - Electronic Parts

INDUSTRIAL COMPONENTS CORP.

Wholesale Electronic Supplies
2551 Boston Rd.
North Wilbraham, Mass.
Telephone 596-3854

Batteries - Tubes - Electronic Parts

YOU KNOW YOU'RE GETTING OLD WHEN:

- ...Almost everything hurts, and what doesn't hurt, doesn't work anymore!
- ...It feels like the morning after the night before, but you haven't been anywhere!
- ...All the names in your little black book end in "MD"!
- ...You get winded playing chess!
- ...You look forward to a dull evening!
- ...You still chase women, but have forgotten why!
- ...You turn out the light for economic, not romantic, reasons!
- ...Your knees buckle but your belt won't!
- ...You are 17 around the neck, 42 around the waist, and 126 around the golf course!
- ...You sink your teeth into a steak and they stay there!
- ...You try to straighten the wrinkles in your socks and you aren't wearing any!
- ...You send CQ with your hand while sitting in church!

TNX Howard, W1JWV

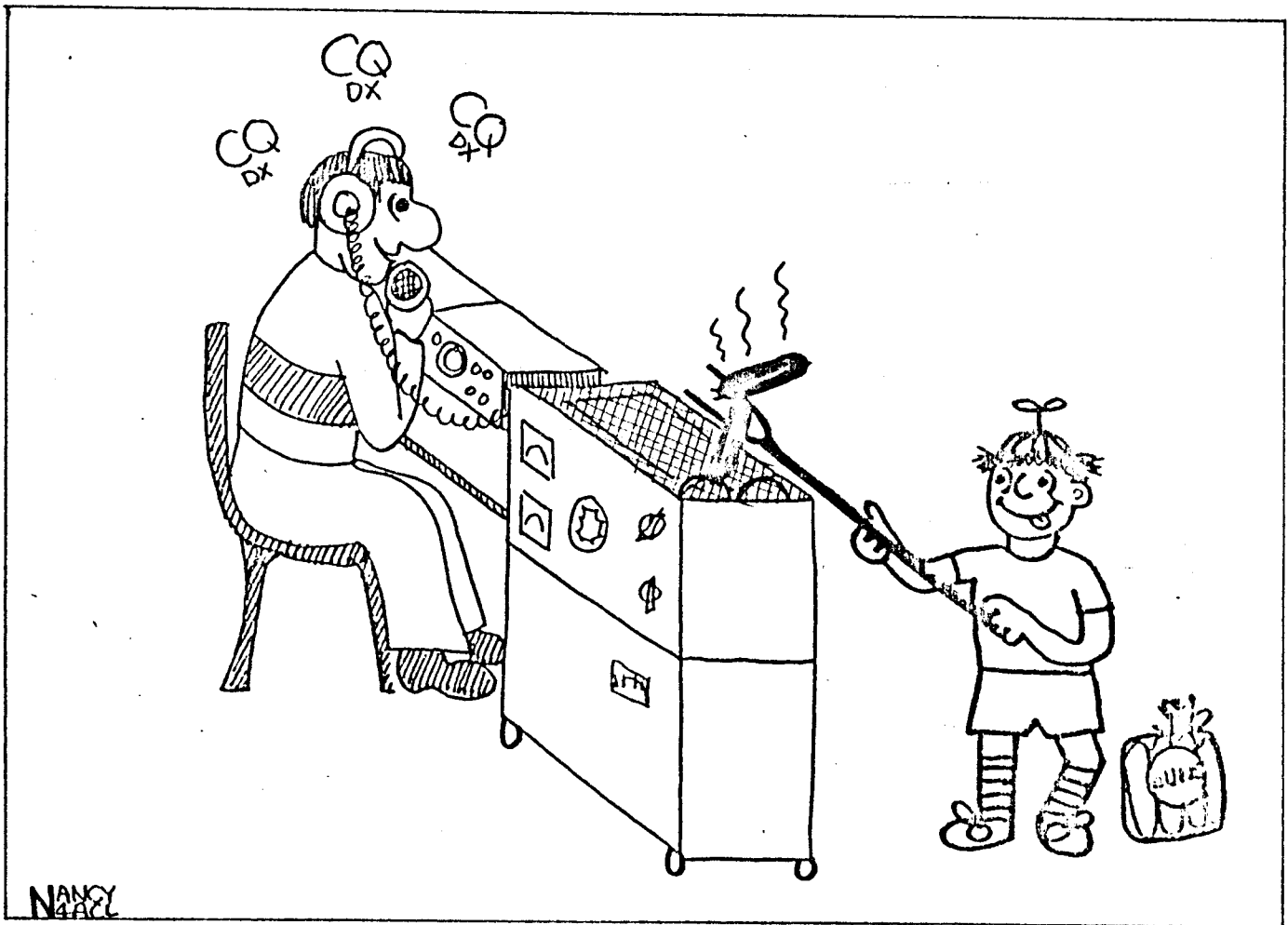

PETITION

We, the undersigned members of Hampden County Radio Association, do hereby petition the Board of Directors to make the Courage Handi-ham system a club project. The purpose of this project will be to encourage and promote participation in amateur radio by handicapped persons. The project will be organized along the lines of the QSL bureau, to wit: a manager appointed by the board who will be responsible for its operation.

We, the undersigned, understand that by signing this petition we are stating our willingness to help make the project a success.

JANUARY 1982

NAME CALL

I didn't get a chance to open my mouth at the last meeting, so this will be at the February meeting. Not much interest shown so far.

TIDBITS

N1PF built a new workbench...W1QWJ has a tri-bander up, is working on a project for the ARRL handbook... W1UKR, W1KUL, and W1KUE using dipoles to talk to their friends in W. Mass from Florida...W1HKN is the radio officer of the town of Irving...W1HIH is our new SEC. ...From September 1965 Zero Beat- W1CQF won the novice roundup with 10,850 points, K1PKZ passed Extra class...W1ZEV is engaged to be married, FB, Steve...K1BE promoted to third degree black belt in Japanese judo...W1UD has made the "A-1 operator's club"... W1APD, W1EHS have a new TS 830S...New Mt. Tom ARA officers- N1AHW, prez; K1BNN, VP; N1AUR, Intermod editor!...

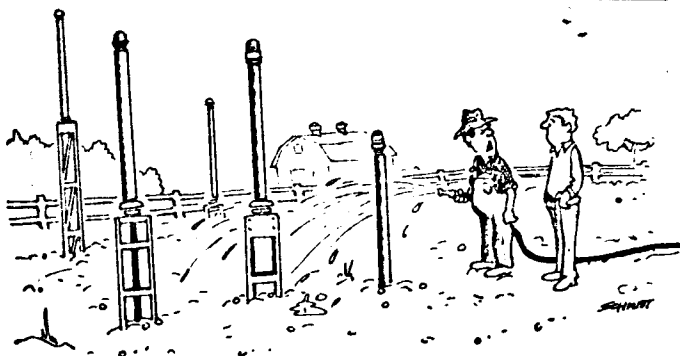

"It's an antenna farm."

WE WANT YOU!!!!

TO CHECK INTO THESE NETS:
(All Times Local)

WMEN	3937 khz
lsb	8:30 am Sundays
WMPN	3935 khz
lsb	M-F 4:30 pm
WMN	3562 khz
cw	7 pm daily
Mt Tom Info net	7:30 pm Weds.
146.34/.94	8:45 am Sunday
FM	

Bring your traffic and other info to these nets. Don't be shy!

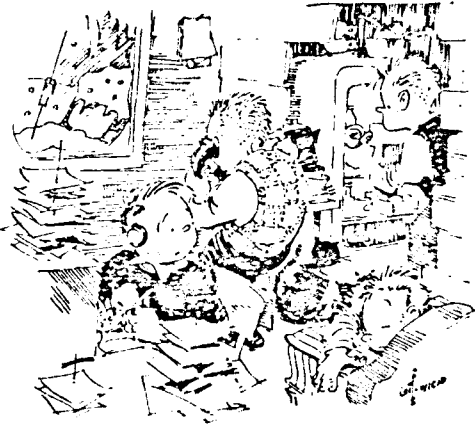

VHF SWEEPSTAKES!!!!

Below zero temperatures, mediocre band conditions, and more local activity than ever before! That was the VHF SS, '82! Six meters had a very high noise level, with even New York very hard to hear. The Provin Mountain boys got on, and boosted everyone's score. Mt. Tom club was represented this year, too! We won't tell you the temperatures

up on the mountain in Washington, where W1RWU's gang operated, it would send a shiver down your spine. The fellows at W1LETS (our own club prez) did a bang up job, and sometimes stopped partying long enough to make a contact.

Have no idea what the total club score was, but get those logs into the ARRL today. Every log counts, no matter what! May or June QST will have the scores, but we sure set a new record for participation. Many thanks to all. And now, in the 1983 SS, what we'll do is.....

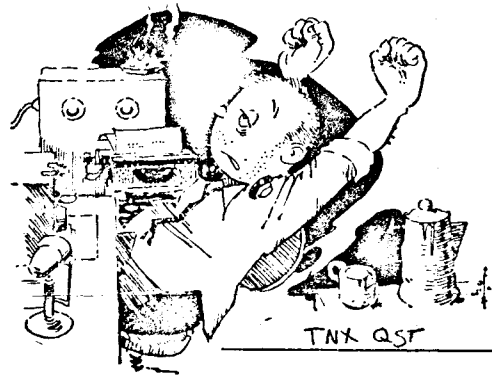

PRODUCT REVIEW:

"Getting Started With TRS-80 BASIC" RS Cat # 26-2107 \$6.95

Radio Shack BASIC Course Part I \$14.95 (tape course)

If you're interested in learning more about data processing and computers, both of these are to be recommended. The book assumes you know nothing, and takes you through step by step lessons in BASIC language usage. A TRS-80 is needed to do the learn-by-doing drills.

The BASIC course is a four tape preprogramed course that uses graphics, questions and answers, etc to teach you the language. If you don't answer the question correctly they start all over again. Like the book, it is a simple, bite-by-bite lesson plan.

It is similar to the army repetitive learning courses. Everything is done at your own learning rate. You would have to have access to a TRS-80 to use this course, too.

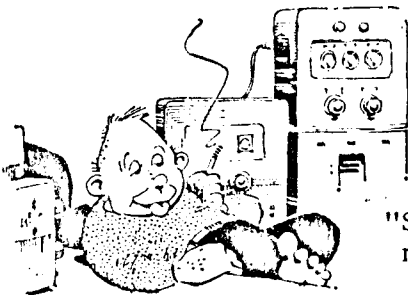

"Six weeks ago I cudn't even spel competur progumar, and now I are one!!!"

TNX QST

ZERO BEAT

OSCAR 9 TELEMETRY

By Bruce Balla, VE2QO

Telemetry from OSCAR -9 since launch on 6 October 1981 have been asynchronous data transmissions. One speed used is 300 baud ASCII. The format is afsk using 1200 hertz (mark) and 2400 hertz (space).

To receive these data transmissions, a demodulator is required. A modified ST-5 or the 565 phase lock loop (PLL) circuit shown in figure one performs well if the signal is full quieting. Each telemetry block starts with AMSAT followed by numbered five-digit code groups. Interpretations of the data will be published by the University of Surrey in England.

Listen for the OSCAR 9 signal on an FM receiver tuned to 145.825 Mhz. There is some fading and flutter due to satellite motion. Doppler shift is 3 to 4 khz (down), but receiver detuning is not necessary. Hams report hearing a strong signal even on hand helds! Orbital predictions are published in QST and by W1AW. Let Zero Beat know when you copy our newest satellite!

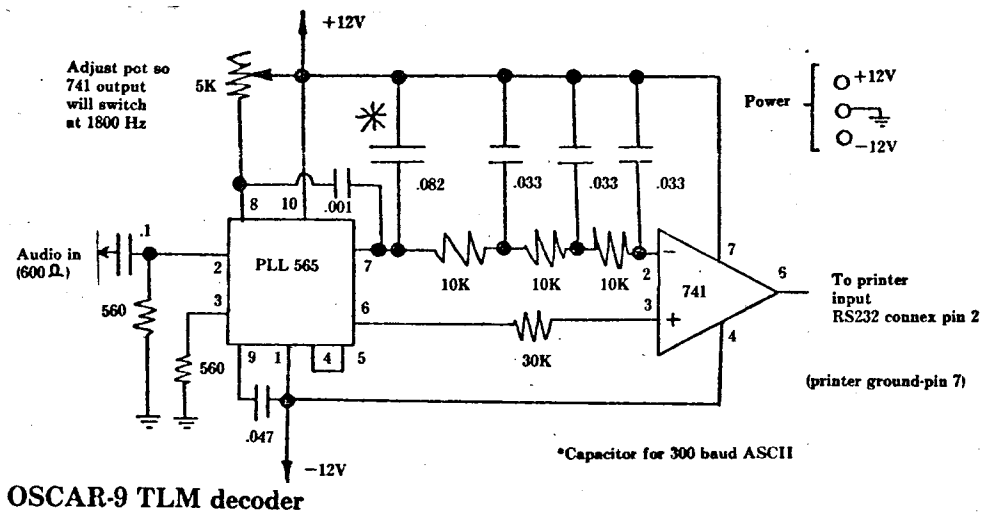

Tnx "Worldradio"



Are you ready for winter emergency communications? Or will you be one of the people that will need help? Are the batteries fresh? Mobile antennas, etc ready to go?

TAKE THE TIME TO GET READY BEFORE YOUR HELP IS NEEDED!!!!

HISTORY of HAMPDEN COUNTY RADIO ASSOCIATION, INC
ANON (circa 1965)



While Hampden County Radio Association isn't to be confused with any preceding club activity in this area, I want to touch briefly on some of the pioneer activities that go back many years, and I would like to have you note how many individuals we know that have sustained an interest in the hobby for forty-five years or more!

In 1919, W1UD, the late Ike Creaser, headed a group that met in the State Street Baptist Church, and at his shack. This group hung up many firsts in radio- broadcasting the Willard-Dempsey fight, sponsoring a hamfest in 1928, working with the military in the early air races around 1931 at Bowles Airport, and serving as a relay group for military traffic.

Back in 1923, as many of you know, Howard Gurney, W1IC, still going strong, scored a first by setting up receiving gear in the Hampden Church so that the congregation could hear the service from the South Congregational Church in Springfield, when their own pastor was absent. Howard's feat made the New York papers, and they called it a big step forward in the use of radio!

Going ahead some years, the Springfield paper of May 24, 1931, carried a picture of the radio club at that time with a membership of 25, and to show you how hams continue their interest, I'll call the roll so you can pick out the names of those you know or remember, because some are "silent keys": President, Percy Noble, W1BVR; VP, Harry Fisk; Ike Creaser, John Burdett, Cy Sias, Frank Cushing, Mal Robertson, Fred Robertson, Ray Clancy, Don Cole, Ed Swanson, Carl Honiker, Earl Hewison, M. Hill and E. Cushing.

On the same page of that paper was a flash that may interest the ARRL. Here it is- W1BDI had just relayed to W3BWT in Washington, D.C. a message he received from Beirut, Syria, from the National Geographic expedition saying that they had just entered the sacred city of Meshed in Persia. (ed note...?)

In 1933, a ham well known to all of us, W1HDQ, got his ticket.

In the latter part of the '30s, there was little if any club activity as far as I can determine, but hams were active in DX contests, experimenting with 5 meters, handling 1938 hurricane traffic, and participating in Army Radio System drills and traffic handling every Sunday morning at 9 o'clock.

Amateur activity came to a near standstill soon after our drill on Sunday, December 7, 1941, when word was flashed of the Japanese attack on Pearl Harbor. All amateur gear had to be reported to the government, and all hams had to report to the police for fingerprinting. During the war years, younger amateurs were in the service, while the oldsters went into fixed or mobile 2 1/2 meter emergency set-ups. Operators of these units had to carry special identification so they could move about during alerts or blackouts without being detained by police or wardens.

With the opening of the 2 meter band after the war, 144 mc groups quickly formed all over the country, and hams in this area were no exception. Although VHF activity was excellent, it did not have the breadth of appeal and interest to fill the void that an honest-to-goodness and well balanced club could do.

Consequently in November of 1947, Amateurs W1's KUE, JQ, FOF, JYH, NY, KJV, IJT, OBQ, APA, LRE, and NLE, decided that a club was badly needed. All these fellows had seen clubs come and go, and so they were determined to create a framework of by-laws and constitution that would stand the wear and tear of years to come. How well they built we all know!

ZERO BEAT

After much thought and discussion with amateurs interested in all the different phases of our hobby, the Hampden County Radio Club was offered to all radio amateurs in the area in a kind of package deal in October, 1948, and the first meeting was held the next month.

It is quite significant that many of the original creators of the club are still among us, and may I read the first slate of officers: President, Gil Williams, W1APA; VP- Wes Thayer, W1LRE; Sec'y- Clarence Bordeau, W1IJT; Treas- Bob Adolphson, W1NLE. Exec Committee- W1's APA, LRE, IJT, KUE, EOB, JYH, KFV, OBQ, QXV, QWJ, and RFU.

Rog Corey, W1JYH, realizing that club members needed some medium to keep them in touch with club activities, conceived the idea of a monthly bulletin, and found himself stuck with the job of editor! The end result was our Zero Beat which has gone out to our members ever since, and has been credited with keeping up the interest and support of the club members in a great measure.

Jumping ahead a bit, by 1952 the club had grown to a healthy one with a membership of 94, which included amateurs from Hampden and Hampshire counties, and Connecticut in ages from youngsters to oldsters. In June of that year we sponsored the ARRL New England Division Convention and Hamfest, in the Industrial Arts Building of the Eastern States Exposition Grounds. Attendance was about 2500 hams from all parts of New England, New York and New Jersey. All the club members co-operated enthusiastically, playing parts big and small, in making it a most successful project.

There is a close connection between the activities of club members and the interest and enthusiasm they impart to other members. I don't expect that I have made a complete listing of club members who have been outstanding in various phases of amateur activity, and if you were omitted, don't feel it was intentional, it wasn't!

Our early Zero Beat editor, Rog Corey, now transferred to Westwood, was always interested in contests and DX. He's still at it and was named the top dog in January QST for winning the July CD contest. Bill Rosner, ex-W1RFU, broke world records for DX on the VHF bands in the middle 1950's.

Dick Stevens, W1QWJ, radio instructor, expert on micro-wave transmission, and experimenter in the UHF field, has given us information, inspiration, and entertainment, frequently aided and abetted by his side kick, Pete Pederson, W1RVW.

Hal Atwater, W1VNH, by his devotion to 2 and 6 meter activities, could always be counted on to run up an impressive score when we battled the Hartford Radio Club in the VHF contests, and he is still at it and reaching out into UHF fields.

So many members have added to the success and good fellowship of the club, that all can take credit and take pride in its progress. A whole evening could be used up listing the public services where our members have been active- W1's- MNG, BVR, FAB, VBG, DGJ, and many others are constantly linking service men with their home folks.

Our TVI committee has been of immeasurable value in improving the ham radio image in the eyes of the public. When people began to learn that heating pads, hearing aids, neon signs, diathermy machines, and florescent lights could louse a TV up just as nicely as an overdriven ham transmitter, some of them began to realize that the amateur might not be as big of a devil as he had been pictured.

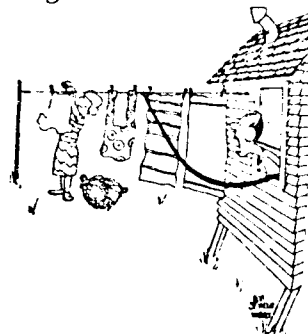

The years 1948 to the present have been marked by an interesting, ever growing club with members playing a significant part in communications during floods and hurricanes, conducting code practice and technical sessions, participating in field day and vhf contest activities, civilian defense drills, all women's transcontinental air races, MARS operation, and testing and perfecting ham gear.

A summary of the club's history wouldn't be complete without paying tribute to some of our "silent keys". Carl Morris, W1VBG was honored last October 27th with a special citation in braille from the Air Force for his constant service as a civilian operator working in their behalf. Frank Cushing, W1AWW, went back to the earliest days of ham radio. He founded a company that for many years was the one sure place a ham could get the part he wanted to homebrew. He was an interested member of the club until failing health curbed many of his activities.

Perhaps it is a sign of age or maybe experience, when one makes observations, or suggestions, but I'm going to take a chance and hope that these closing remarks won't be amiss.

This club has had a relatively long life so far as radio clubs or associations are concerned. Its future depends on the interest and support of the membership. The Board of Directors has a great responsibility to see that all matters pertaining to policy, procedure, and programming are carefully considered and decided upon in their monthly meetings, and then made known to the members. Many clubs have been weakened, even disbanded, by trying to conduct business from the floor when the club had gathered for an evening of entertainment and good fellowship! I believe our system of handling club affairs has stood the test, and should not be changed or compromised.

Perhaps the greatest responsibility for successfully perpetuating a club rests on the shoulders of the nominating committee. Under our procedure, nomination is usually tantamount to election, and so a nominee should have more than a passing interest in the hobby, should be familiar with the fundamentals of good amateur practice, tradition, and procedure, and should not favor a course that would be a radical departure from the policies that have brought this club successfully through the past.

(written February 5, 1965)

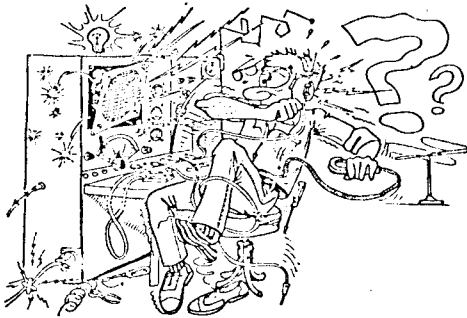

DID YOU KNOW?

THAT DETONATION OF A NUCLEAR WEAPON CAUSES AN ELECTROMAGNETIC PULSE (EMP) WHICH IS SIMILAR TO THE ELECTRIC POWER SURGE CREATED WHEN LIGHTNING STRIKES A POWER LINE

EMP CAN DAMAGE ELECTRICAL SYSTEMS

BUT THERE ARE WAYS TO SHIELD ELECTRICAL SYSTEMS TO PROTECT THEM FROM **EMP**

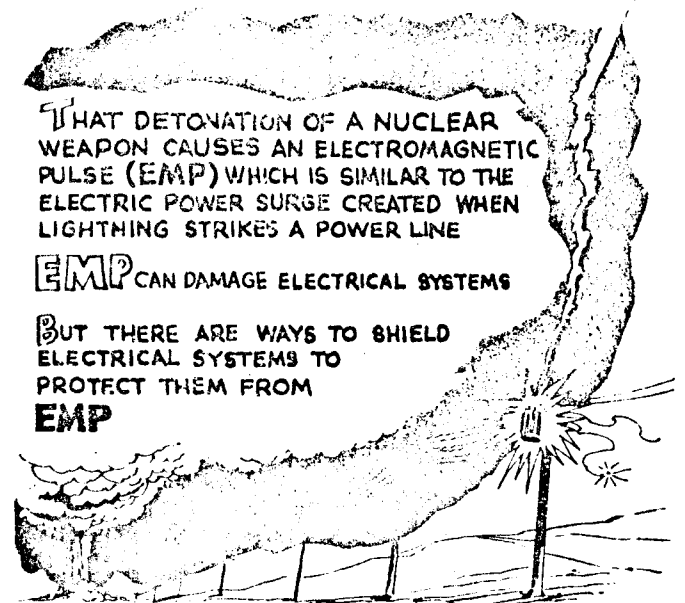

FOR SALE COMPUTER	RADIO SHACK TRS 80 LEVEL 1 16K SYSTEM includes CTR 41 cassette, Games package, plus software	\$400.00
2m FM rig	DRAKE TR22 plus Crystals, leather case, rubber duck, Drake 1525EM touch tone mic, DRAKE under dash mount, 12volt supply, nicad bateries, and external nicad supply	\$140.00
High Freq. rig	H.F. station Yaesu FTdx570, 560 watts PEP max., mint cond. CW Filter, Unique wire Tuner, matching external speaker Heathkit Cantenna Dummy Load yaesu yd844 microphone	\$500.00

CALL KALCRG 525-6202

ARRL QN Signals for CW Net Use

- QNA*** - Answer in prearranged order.
- QNB*** - Act as relay *Between* ... and ...
- QNC** - All net stations Copy.
I have a message for all net stations.
- QND*** - Net is *Directed* (controlled by net control station).
- QNE*** - Entire net stand by.
- QNF** - Net is *Free* (not controlled).
- QNG** - Take over as net control station.
- QNH** - Your net frequency is *High*.
- QNI** - Net stations report *In*. * I am reporting into the net. (Follow with a list of traffic or QRU.)
- QNJ** - Can you copy me? Can you copy ...?
- QNK*** Transmit messages for ... to
- QNL** - Your net frequency is *Low*.

- QNM*** - You are QRMing the net. Stand by.
- QNN** - Net control station is ... What station has net control?
- QNO** - Station is leaving the net.
- QNP** - Unable to copy you. Unable to copy ...
- QNQ*** - Move frequency to ... and wait for ... to finish handling traffic. Then send him traffic for ...
- QNR*** - Answer ... and Receive traffic.
- QNS** - Following Stations are in the net.* (Follow with list.) Request list of stations in the net.
- QNT** - I request permission to leave the net for ... minutes.
- QNU*** - The net has traffic for you. Stand by.
- QNV*** - Establish contact with ... on this frequency. If successful, move to ... and send him traffic for ...

- QNW** - How do I route messages for ...?
- QNX** - You are excused from the net.* Request to be excused from the net.
- QNY*** - Shift to another frequency (or to ... kHz) to clear traffic with ...
- QNZ** - Zero beat your signal with mine.

*For use only by the Net Control Station.

Notes on Use of QN Signals

The QN signals listed above are special ARRL signals for use in amateur cw nets *only*. They are not for use in casual amateur conversation. Other meanings that may be used in other services do not apply. Do not use QN signals on phone nets. *Say it with words*. QN signals need not be followed by a question mark, even though the meaning may be interrogatory.

KERCHUNK

The following article appeared originally in the Static Sheet, Des Moines Amateur Radio Club, and was reprinted in the Electron, Sterling-Rock Falls Amateur Radio Soc.

The Kerchunkers (Des Moines Chapter) meet each day when the repeater is not in use. To qualify as a kerchunker, one must show his skill by pressing the microphone button long enough to activate the repeater, but not long enough to ID or be identified. To be certified as a Kerchunker, one must follow this procedure successively until the mike finger fatigues or someone wants to use the repeater.

Be very careful to kerchunk when you know no one is listening, so that legitimate repeater users will not be irritated and put an anti-kerchunk device on the repeater. By being a Certified Kerchunker, one can enjoy the following:

1. See if your transmitter can access the repeater.
2. See if the repeater can hear your transmitter.
3. Enjoy the excitement of hearing the squelch tail.
4. See if the repeater is "up".
5. Use the repeater without having to talk to anyone.

It is a real thrill to put your license, your rig, and the repeater to use by kerchunking. And, be sure to complain when the repeater is "down".

The Kerchunkers are not taking any new applications for membership at this time, as we have too many members now.

(By I.K. Dumb, Chief Kerchunker)

HOLYOKE ROTARY CLUB GETS INTRODUCTION TO HAM RADIO

On Dec. 1st W1MM introduced the rotary club to the world of Amateur Radio by showing the ARRL film THE WORLD of AMATEUR RADIO.

HAMPDEN COUNTY RADIO ASSOCIATION, INC.

date	Calendar for 1982 Topic	chairman	speaker
Feb. 5	International DX	Steve WALEYF	K1MM Bill
Mar. 5	Linear Amps	Dick N8BQU	K8CH Chuck
apr. 2	VHF, UHF, & Moonbounce	John AC1t	K1WHS Dave
May 7	Flea Market	Larry K1cXU	
Jun. 4	Banquet		

HAMPDEN COUNTY RADIO ASSOCIATION, INC.
 RAY MORIN, K1LCRG, EDITOR
 97 BROOKHAVEN DRIVE
 EAST LONGMEADOW, MASS. 01028

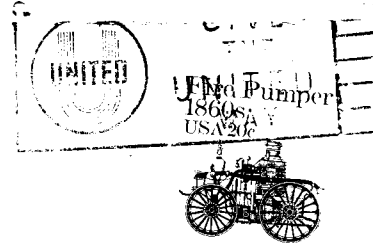

FEB. ZERO BEAT 82

AC1T

10/82